





## Table of contents

Philosophy	4
Intensity	5
Supported systems	6 - 7
Alu	8 - 11
Bronze	12 - 13
Metal	14 - 15
Gold	16
Copper Rose	17
Glass	18 - 19
Corian®	20 - 21
Stone	22 - 23
Wood	24 - 25
Landscape	26 - 27
Serenity	28 - 29
Velocity	30 - 31
Invisible	32 - 33
Wallpaper	34
Paintable	35
Integrated	36 - 37
Infinity	38 - 39
Infinity 4 fold	40 - 41
Infinity 8 fold	42
Demonstration Tools	43
Motivity	44
Motivity Wall	45
Motivity Ceiling	46
Motivity Line	47
Motivity Plus	48 - 49
Socket frames	50 - 51
Integrated Socket frames	52 - 53
Invisible	54 - 55
Paintable Socket frames	56 - 57
Eyeswitch	58 - 59
Hotel switch	60
Customizations	61
Installation	62
Marketing tools	63
Trimless	64 - 65
Xillo	66 - 69
Order codes	70 - 79

*The displayed images are for reference only.*

# Philosophy

**XILLO**  
INNOVATIVE RECESSED SOLUTIONS

[www.xillo.be](http://www.xillo.be)

## COMPANY

Tense is the Belgian designer and manufacturer of elegant design switches, room controllers with OLED display and motion detectors. Furthermore, we offer socket frames and iPad holders in the same materials that match our product line to create a uniform look in your interior. All Tense design products can be flush-mounted thanks to the unique Xillo fixtures. The products are KNX compatible, can operate on 12-24V DC or can be connected to 100-240V AC installations. If you'd rather integrate your switches into your wall's finish; we do have a solution for that too: the Integrated range!

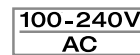

Tense combines more than 25 years of experience in home automation, electronics manufacturing and lighting. As being an ISO 9001 certified company, Tense always aims to exceed its customers' expectations of top quality, innovative R&D, unbeatable service, in-time delivery and professional export handling.

## PRODUCTS

These high-quality products are stylish, easy to use, very reliable, designed with passion and were crowned by winning several design awards. Only the best technologies and premium raw materials are used to create our unique Tense products.

DESIGNED, MANUFACTURED & HANDMADE IN BELGIUM.



# Intensity

The Intensity is a stern switch which beautifully combines **functionality and elegant design**. These switches are **capacitive-touch** based.

What kind of **finish** would you prefer? All of the following **materials** are available for the Intensity:

Metal      Glass      Corian®      Stone      Wood      Composite

This makes the Intensity the **most wanted element** in any interior and is **user-friendly** due to the easy operation capabilities.

The Intensity is available with **1, 2, 4 or 8 touch zones**.

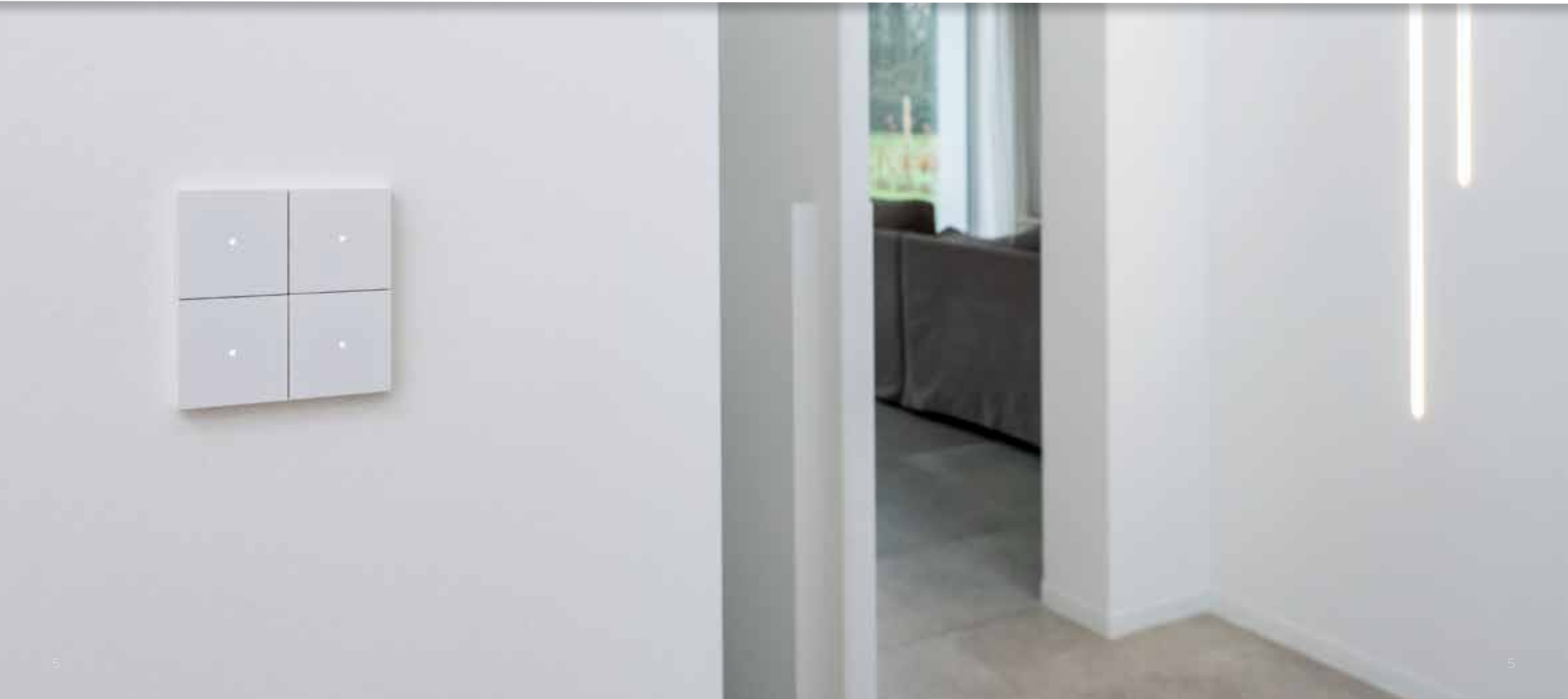



# Supported systems

## KNX INTEGRATION

Every KNX Intensity has four functions:

1. Touch:
  - Every touch zone has a double function with both short and long touch capability
  - Touching at least two buttons at the same time activates the **multi-touch** which has both a short as a long multitouch function. For an Intensity with 4 touch zones, this adds up to 10 touch functions.
2. Temperature:
  - Thermostat function through its built-in temperature sensor or by connecting an external KNX temperature sensor.
3. LED feedback:
  - All switches have individual dimmable RGB LED feedback per touch zone, which can be customized according to your wishes via the ETS software of KNX.
4. Other functionalities:
  - Dimming, blind control, shutter control, scene module, timers, basic logic functions, up/down counters.

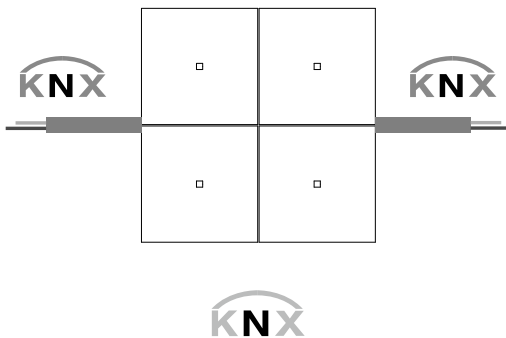

## EXTERNAL SYSTEM INTEGRATION

Every NOC  
Intensity has **two** functions:

1. Touch:
  - The processing of the generated touch signals depends on the connected third party input module.
  - **Multi-touch** output is supported without separate channel.
2. LED feedback:
  - Switches have individual white LED feedback per touch zone, which is adjustable in 2 settings:
    - When untouched, 70% brightness from the white LED is shown. When touched, the white LED will light up to 100% brightness.
    - When untouched, no LED brightness is shown. When touched, the white LED will light up to 100% brightness.

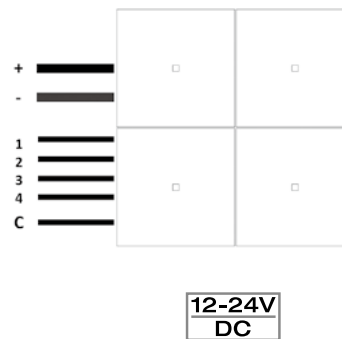

## EXISTING SYSTEM INTEGRATION

Every RETROFIT Intensity has **three** functions:  
2023-2024

Types:

### 1. Relay

- Basic relay operation (on/off)
- Timed relay operation ( during a selectable period)

### 2. Touch:

- Every touch zone has a double function with both short and long touch capability.
- Individually adapted touch functions per front type (1F, 2F, 4F).

### 3. LED feedback:

- Switches have individual white LED feedback per touch zone, which is adjustable in 2 settings:
  - When untouched 70% brightness from the white LED is shown. When touched, the white LED will light up to 100% brightness.
  - When untouched no LED brightness is shown. When touched, the white LED will light up to 100% brightness.

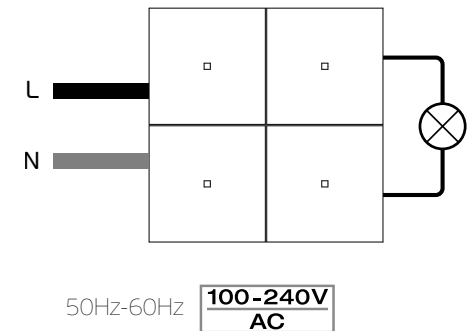







Alu White  
INTAW

Alu  
INTA

Forged Alu  
INTFA

Alu Dark Grey  
INTADG

Forged Alu Dark Grey  
INTFADG

Alu Black  
INTAB

Forged Alu Black  
INTFAB

## Intensity alu

The modern design defines the Intensity aluminium range and fits in every contemporary interior.

The Intensity Alu White is coated in RAL9016 and needs to be cleaned with non-aggressive, non-solvent based cleansers. These are all handmade products which makes every switch unique.

Colour variations in Alu Dark Grey may occur.



12-24V  
DC

100V-240V  
AC



AVAILABLE IN  
ANY  
RAL COLOUR  
OF YOUR CHOICE



## Intensity alu RAL

The colourful design defines the Intensity aluminium range and fits in every special interior.  
The Intensity Alu RAL can be coated in any RAL colour of your choice and is thus a special non-stock item.



12-24V  
DC

100V-240V  
AC





Bronze Light  
INTBL

Forged Bronze Light  
INTFBL

Bronze  
INTB

Forged Bronze  
INTFB

## Intensity bronze

The stylish bronze and bronze light finishes are achieved by a **long-established bronzing process of brass raw material**, which honours the **craftsmanship** that has existed for decades. Bronzing is an **artisanal process**, therefore colour variations between products may occur. These finishes are protected with a semi-matte varnish. These are all **handmade products** which makes every switch unique. Admire the deep living colour of the bronzed brass.

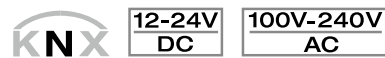



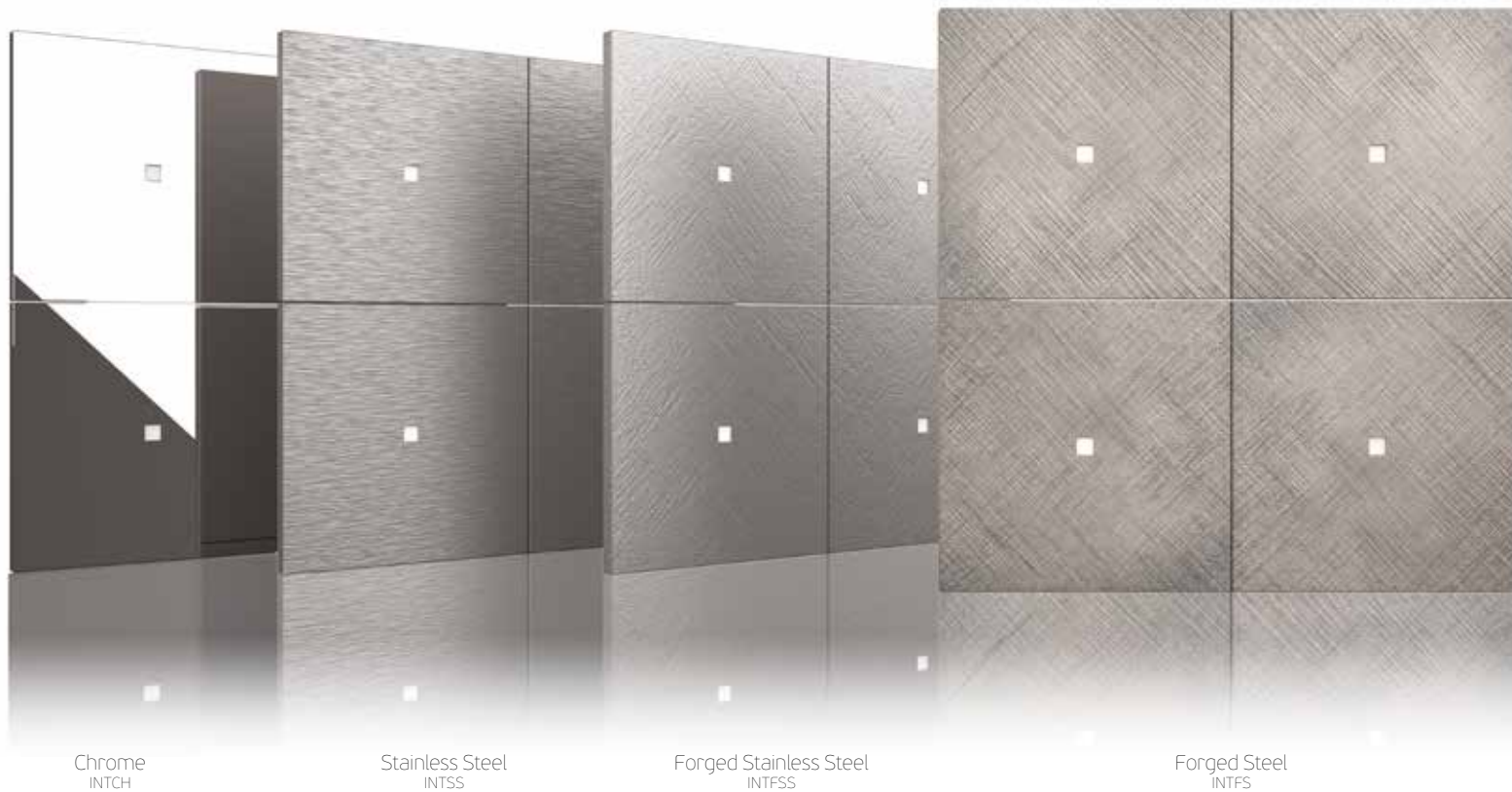

## Intensity metal

These finishes induce an **extraordinary look and feel**. The chrome look has been obtained as the result of a craftsmanship process where stainless steel is polished. The Forged Steel finish gives an **old industrial and rough look** and is protected with a semi-matte varnish. These are all **handmade products** which makes every switch unique.





Forged Gold  
INTFG

Brushed Gold  
INTBG

## Intensity gold

These finishes induce an extraordinary look and feel, your switches can either blend in or stand out.

These finishes are protected with a semi-matte varnish.

These are all handmade products which makes every switch unique.

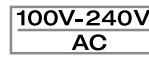





Brushed Copper Rose  
INTBCR

Forged Copper Rose  
INTFCR

## Intensity copper rose

Looking for an elegant and **trendy touch** in your interior? Then Copper Rose is definitely a must have. This stylish finish is an **eye-catcher** in any contemporary interior. These finishes are protected with a semi-matte varnish. These are all **handmade** products which makes every switch unique.



12-24V  
DC

100V-240V  
AC



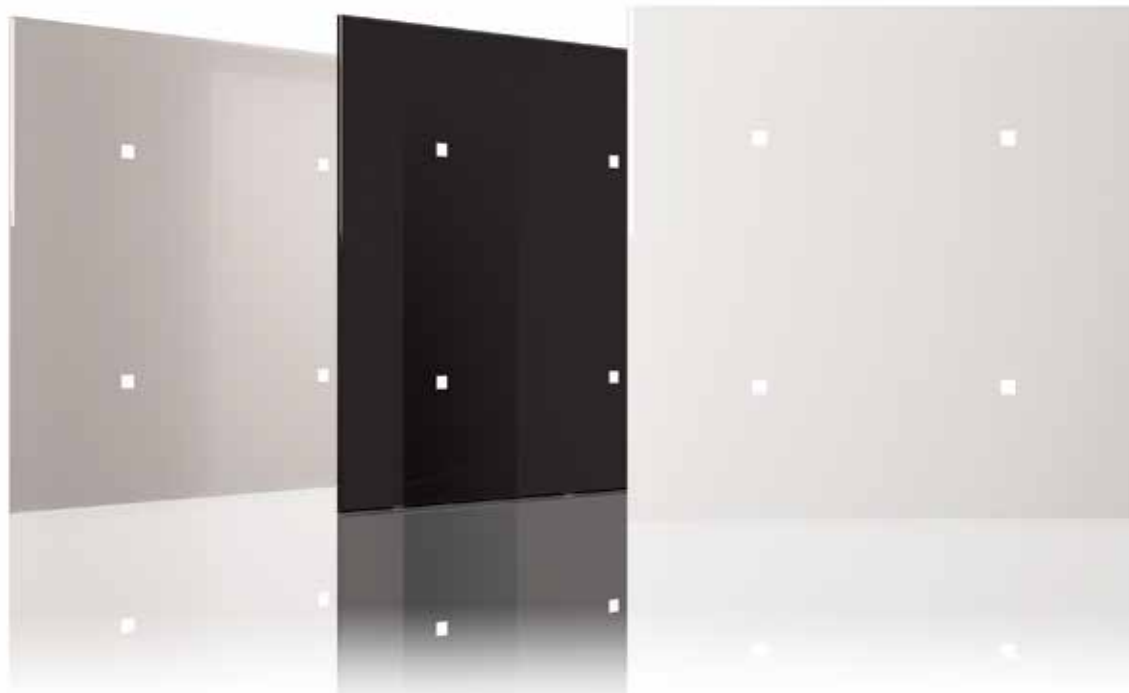

Silver  
INTGS

Black  
INTGB

White  
INTGW

## Intensity glass

The premium design glass front is coated with several layers of high-quality ink through silk screen printing. The available colours are: RAL7001 (silver) until obsolete, RAL9017 (black) or RAL9016 (white).



12-24V  
DC

100V-240V  
AC



AVAILABLE IN  
DIFFERENT  
COLOURS

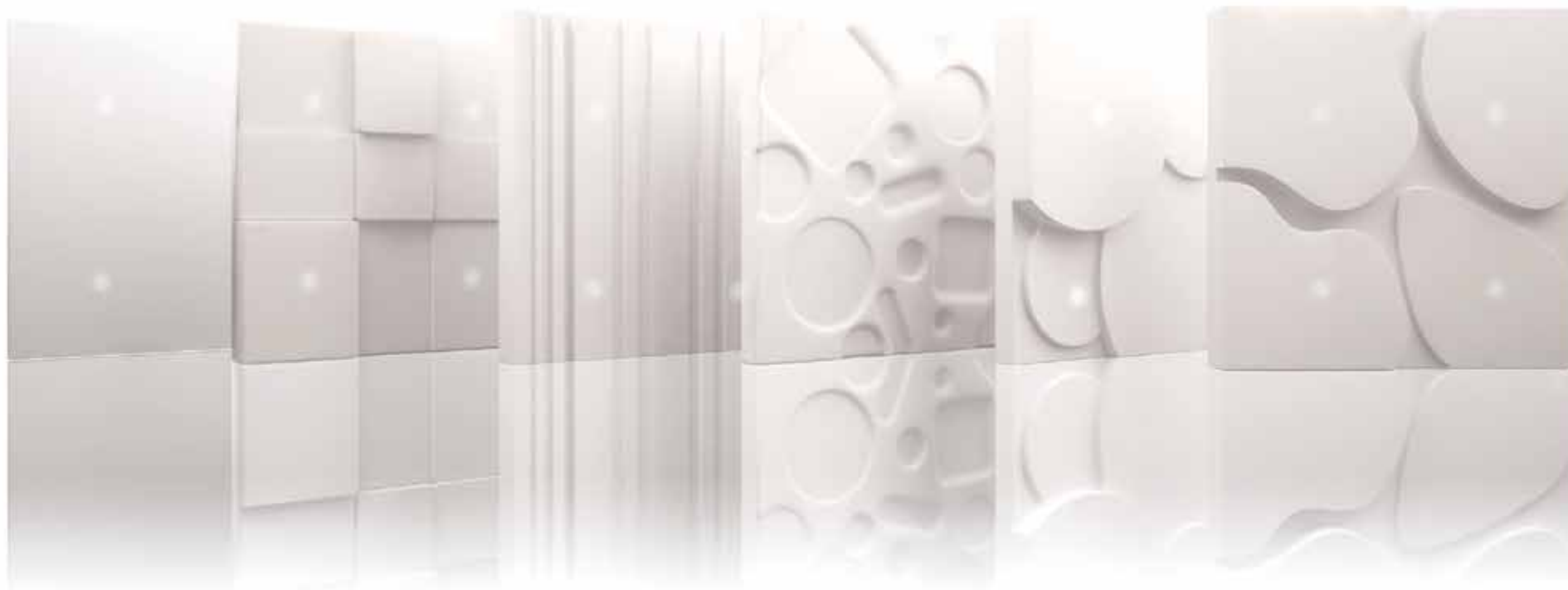

White  
INTCW

Carrea White  
INTCCAW

Linea White  
INTCLW

Organica White  
INTCORW

Ronda White  
INTCROW

Claudia White  
INTCCLW

Black  
INTCB

## Intensity Corian®

Corian®, this maintenance friendly material is often used in kitchens and bathrooms.

The simplicity in the design of the Corian® White switch offers you a smooth and clean design look.

The refined colours of Corian® allow you to create a colourful, inspiring and custom made switch (INTCRAL...).



12-24V  
DC

100V-240V  
AC



INTSEMM4  
Stone Emperador Marron Marble



French White  
INTSWW

Belgian Blue  
INTSBB

Carrara Bianco Marble  
INTSCBM

Ceppo Di Gres Limestone  
INTSCDGL

Calacatta Marble  
INTSCM

Emperador Grey Marble  
INTSEGM

Oak White Marble  
INTSOWM

Emperador Marron Marble  
INTSEMM

## Intensity stone

These carefully selected natural stones are warm and classy elements to decorate your interior.

Depending on the stone type, some fronts are polished and other ones maintain the natural rough surface.

Stone is a natural material and therefore every switch is unique in colour and texture. Other stone types available on request, or make your own stone plate and glue it to our electronics.



12-24V  
DC

100V-240V  
AC







Walnut  
INTWWA

Wenge  
INTWWE

Afrormosia  
INTWAF

Padouk  
INTWPA

Oak Pura Natura  
INTWOPN

Oak Dark  
INTWOD

Oak Cotton White  
INTWOCW

Ash  
INTWAS

## Intensity wood

These classy wooden fronts represent **craftsmanship** and give a **natural look and feel** to your interior. Wood is a **natural product** and can vary in colour and pattern. Therefore, each of our wooden switches is unique. Other wood types on request.

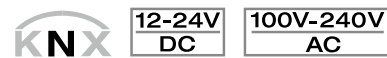



AVAILABLE IN  
ALL METAL  
FINISHES



Alu Black 1 fold  
INTLAB1



Alu Black 2 fold  
INTLAB2



Alu Black 4 fold  
INTLAB4

## Intensity Landscape

The Intensity Landscape switch, specially designed for the Blue Lagoon Hotel\*\*\*\*\* in Iceland, consists of 1, 2 or 4 touch zones.

This switch is available in **all kinds of metal** and is ideal for customizations such as engraving, lasering or printing.

These are all **handmade products**, hence makes every switch unique.

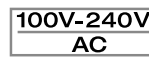



NEW  
AVAILABLE IN  
ALL METAL  
FINISHES



Alu Black 1 fold  
SERAB1



Alu Black 2 fold  
SERAB2



Alu Black 4 fold  
SERAB4

## Serenity

The Serenity is a mechanical switch with 1,2 or 4 buttons with a click feedback and can as well be operated by a single, double or multi-click.

This switch is available in **all kinds of metal** and is ideal for customizations such as **engraving, lasering or printing**.

These are all **handmade products**, hence makes every switch unique.





NEW  
AVAILABLE IN  
ALL METAL  
FINISHES

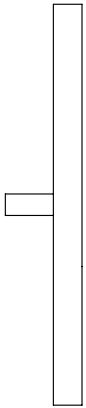

Alu Black 1 fold  
VELAB1

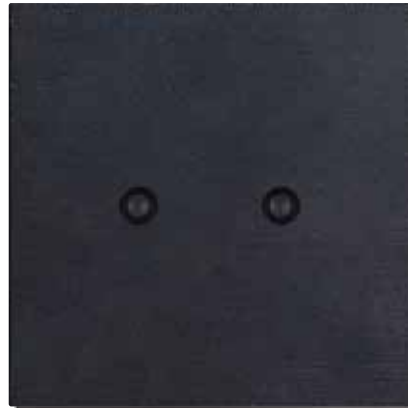

Alu Black 2 fold  
VELAB2



Alu Black 4 fold  
VELAB4

## Velocity

The Velocity is a mechanical switch with 1,2 or 4 buttons with a click feedback and can as well be operated by a single, double or multi-click.

This switch is available in **all kinds of metal** and is ideal for customizations such as **engraving, lasering or printing**.

These are all **handmade products**, hence makes every switch unique.



12-24V  
DC



INTINV4  
Invisible

TRIM\_SWITCHMCWINV124\_P  
Trimless Switch Metal Corian Wood Invisible 1, 2, 4F Plasterboard Wall



## Plasterboard wall (12,5 mm)

TRIM\_SWITCHMCMWINV124\_P & INTINV4



Cut a 225 x 192 x 65 mm rectangular hole in the wall and install 2 wooden planks

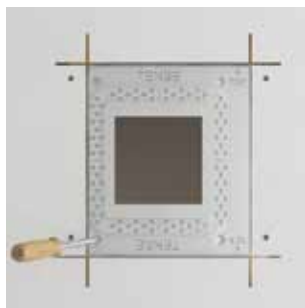

Screw the fixture on the wooden planks by using 4 screws

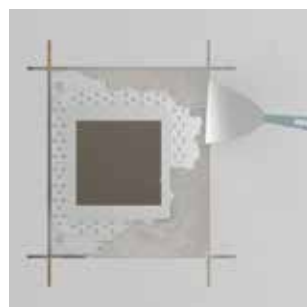

Add fiberglass netting and plaster up to the rounded second level

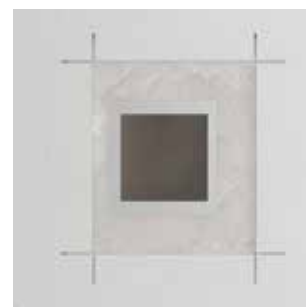

Smoothen with a sanding machine



Paint the wall and the switch



COAT\_SPRAY\_COMP  
 Spray a matte water-based varnish on the switch to protect it and make it cleanable

## Brick/Concrete wall (6 mm)

TRIM\_SWITCHMCMWINV124\_BC & INTINV4

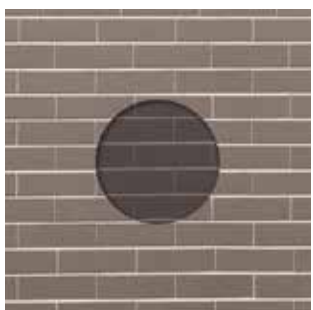

Drill a  $\varnothing$  145 mm hole in the wall



Screw the fixture on the wall by using 4 plugs and screws

## Intensity Invisible

This innovative recessed Invisible 4 fold switch with dimmeable RGB feedback (KNX) in the corners is fast to install (glued or screwed via pre-drilled screw holes/large mounting surface to easily adjust) and easy to plaster thanks to the rounded second level in the Xillo fixture. The Invisible meets the highest finishing standards, is suitable for all surfaces and is available in 6 mm and 12,5 mm thickness.

For the Intensity Invisible switch, the Trimless wall box has to be ordered separately. As well suitable for cement paint application.

For protecting the switch, a matte water-based varnish can be sprayed over the paint (COAT\_SPRAY\_COMP).

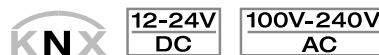



## Intensity Wallpaper

Do you like to blend in your switch on a wallpaper wall? This front is made of a special composite material and the sides can easily be painted in any colour, matching the wall or interior.

Wallpaper, wood veneer, leather, fish skin, cork, cement based paint and other materials of a thickness up to 0,5 mm can be applied in the cut-out.



## Intensity Paintable

Do you like to **subtly integrate** your switch in your interior? Just **paint the front** (on apply a cement paint) and the switch is almost invisible. This front is made of a **special composite material** which can **easily be painted** in any colour and type of paint, matching the wall or interior. For protecting the switch, a matte water-based varnish can be sprayed over the paint (COAT\_SPRAY\_COMP).



12-24V  
DC

100V-240V  
AC



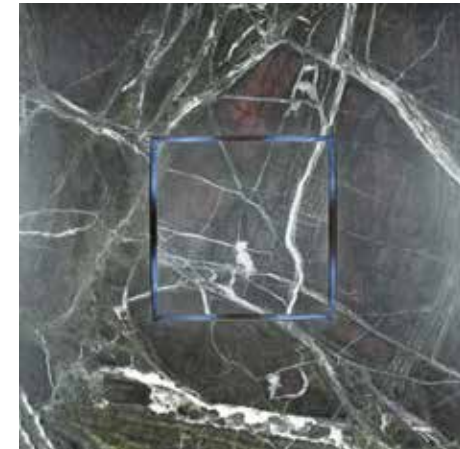
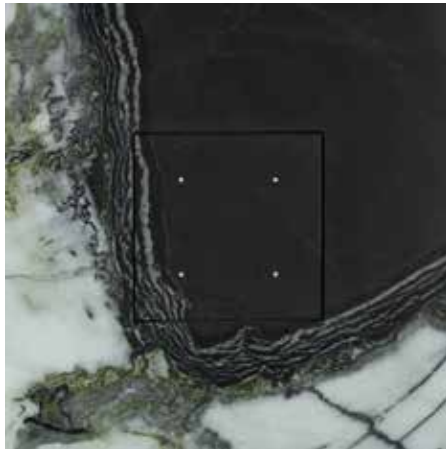

TRIM\_INTINT4\_WG  
Intensity With Gap - 1,25 mm gap

TRIM\_INTINT4\_NG  
Intensity No Gap

TRIM\_INTINVINT4\_WG  
Invisible - 3mm gap

## Intensity Integrated

Tense can now provide you with the electronics and special wallbox to be placed behind a Corian®, Stone, Ceramic, MDF, Painted Glass, Terrazzo or Wooden wall.

This way a foolproof installation of any integrated switch is possible: with gap, no gap, invisible...

Furthermore, we can guide you with the instructions and dimensions regarding the cut-out on the back of those materials.

Do you have a wall in glass, mirror; textile or other special materials? Ask our specialists!

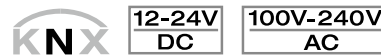



The Infinity is more than a capacitive touch based switch. It opens a box of possibilities on top of what the Intensity switch can do.

Thanks to its **smart OLED display**, functions are numerous and your switch becomes a complete **room controller**.

Would you like to control your audio? Check energy readings? Or do you like to have text feedback concerning, e.g. the thermostat function? The Infinity does it all.

On top of that, the **Infinity** comes in the same range of **materials** as all the other products in the Tense range:

Metal      Glass      Corian®      (Wood)      (Stone)

The Infinity combines the stern designer look whilst incorporating all the extra functionalities of a complete room controller. All these functions are set through the **ETS software** of KNX.

This switch is available with **4 or 8 touch zones**.

Every **KNX Infinity** has **three functions**:

1. Touch:

- Every touch zone has a double function with the **short and long touch capability**.
- By a **short multi-touch** you display the **extra information page**.
- By a **long multi-touch** you enter the **main menu** (e.g.: lights, shutters, blinds, curtains, multimedia, thermostat, motors ...) and you navigate the **main menu** by sliding the upper two buttons. You navigate the **sub menu** by horizontally sliding the lower two buttons.

2. Temperature:

- Thermostat function through its **built-in temperature sensor** or by connecting an **external KNX temperature sensor**.

3. LED feedback:

- All switches have individual dimmable RGB LED feedback per touch zone which can be customized regarding to your wishes.

Infinity





AVAILABLE IN  
METAL  
GLASS  
CORIAN®  
(WOOD)  
(STONE)



Alu  
INFA

Bronze  
INFB

Alu Black  
INFAB

Alu Dark Grey  
INFADG

## Infinity 4 fold

Room controller with 4 direct touch buttons and a menu to control your light settings, blinds, shutters, thermostat, audio ...  
These are all handmade products hence every room controller is unique in colour and texture.

AVAILABLE IN  
METAL  
CORIAN®  
(WOOD)  
(STONE)



## Infinity 8 fold

INFA8  
Alu

Room controllers with 8 direct touchbuttons are available in metal and Corian®.

The OLED display enables you to **visualize** the different functions of your system, e.g., light settings, blinds, shutters, thermostat, audio ...

These are all **handmade products**. Hence every room controller is unique in colour and texture.



## Demonstration tools

Would you like to see, feel and experience the high quality materials of the Tense products?

Select a non-functioning sample with 4 touch buttons in the same finish (DEM\_INT...4). Or choose one of our predefined faceplates (DEM\_INTMIX...).

These are all excellent sales tools to show all the 19 available Tense finishes.

We proudly present our elegant and refined Motivity range.  
You can integrate these **motion detectors** discretely in your interior or use them to make a design statement.

Every KNX Motivity has **four functions**:

**1. Motion detection:**

- Up to **4 different output actions** are available, which can be activated independently under certain conditions (e.g. day/night):
  - Switching
  - Dimming
  - Recalling scenes
  - Sending 1 or 2 byte unsigned values

All these output actions are possible with a **programmable switch-off delay** and can also be **brightness dependent**.

A **blocking object functionality** and **ventilation control** are available as well.

**Master/Slave Mode** is possible.

**2. Brightness detection:**

- Both the Motivity Ceiling White, Motivity Line White and Motivity Plus White are equipped with a brightness sensor.

**3. Temperature:**

- Every Motivity has an internal temperature sensor and a **thermostat function**.

**4. Other functions:**

- Timers
- Scene module
- Basic logic functions
- Up/down counters

Motivity

AVAILABLE IN  
 METAL  
 GLASS  
 CORIAN®  
 STONE  
 WOOD



KNX\_MOTGB



KNX\_MOTGW

DISTANCE FROM OBJECT (m)	MINIMUM DETECTION Ø (m)
0,50	0,86
1,00	1,74
1,50	2,60
2,00	3,48
2,50	4,34
3,00	5,22
3,50	6,08
4,00	6,77
4,50	8,72

360° view, 82° minimal angle

## Motivity Wall

The Motivity Wall is an elegant solution for installing a motion detector in a wall and for who likes to have the same materials as the switches.  
 This motion detector has a built-in temperature sensor.



INSTALLATION HEIGHT (m)	ELEPTICAL AXIS X Ø (m)	ELEPTICAL AXIS Y Ø (m)
1	3,08	2,30
2	6,16	4,70
3	9,24	6,90
4	12,32	9,20
5	15,40	11,50
6	16,00	13,80
7	14,30	14,30
8	12,00	12,00
9	8,70	8,70

360° view, 93° minimal angle

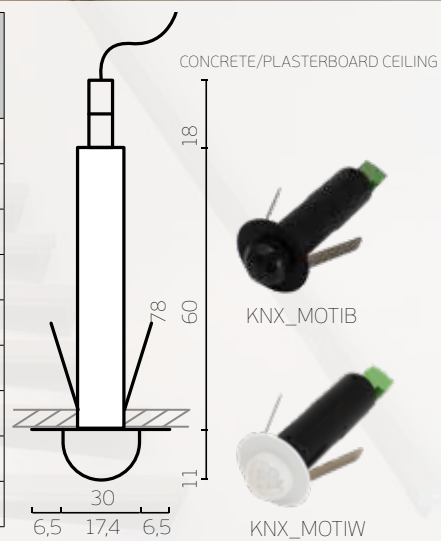

# Motivity Ceiling

This motion detector is one of the smallest detectors in the world with a diameter of only 17,4 mm (drill hole of Ø 18 mm). The black/white plastic rosette can be cut off for a minimalistic end result. The KNX Motivity Ceiling Black (KNX\_MOTIB) contains a motion detector and a temperature sensor, while the Motivity Ceiling White (KNX\_MOTIW) also has the ability to monitor brightness. The 12V DC motion detector exists in white (NOC\_MOTIW) and black (NOC\_MOTIB) and only supports motion detecting. The special SAPP version has been developed for the interalu SAPP office ceilings.

MOTIW  
Motivity Ceiling White

INSTALLATION HEIGHT (m)	ELEPTICAL AXIS X Ø (m)	ELEPTICAL AXIS Y Ø (m)
1	3,20	0,45
2	6,40	0,90
3	8,00	1,30
4	6,00	1,80
4,80	2,60	2,15

35° view, 150° minimal angle

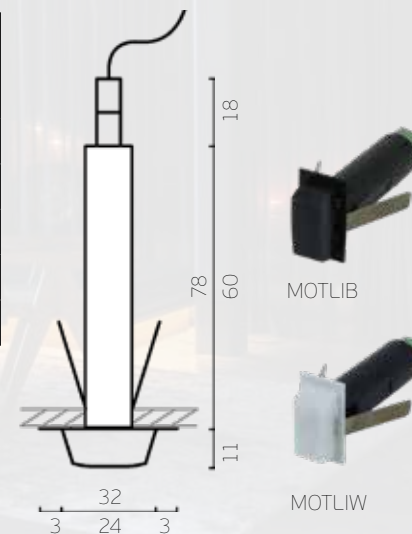

## Motivity Line

MOTLIW  
Motivity Line White

This motion detector is the smallest line detector in the world. The black/white plastic rosette can be cut off for a minimalistic end result.

With its narrow detection zone an ideal choice for hallways, staircases, dressings, alongside the bed... The KNX Motivity Line Black (KNX\_MOTLIB) contains a motion detector and a temperature sensor, while the Motivity Line White (KNX\_MOTLIW) as well has the ability to monitor brightness. The 12V DC motion detector exists also in white (NOC\_MOTIW) and black (NOC\_MOTIB) and only supports motion detecting.







ACCESSORIES



TRIM\_MOTPLUS  
Wallbox for recessed mounting



MOTPLUS\_ANGLE  
Bracket for 45° angled mounting

AVAILABLE IN  
100% RECESSED

INSTALLATION HEIGHT (m)	ELEPTICAL AXIS X Ø (m)	ELEPTICAL AXIS Y Ø (m)
1	2,50	2,10
2	5,00	4,20
3	7,50	6,30
4	10,00	8,40
5	12,50	10,50
6	15,00	12,60
7	17,50	14,70
8	17,90	16,70
9	15,90	15,90
10	13,30	13,30
11	9,60	9,60

360° view, 92° minimal angle

# Motivity Plus

MOTPLUS\_W  
Motivity Plus White

The surface-mount detector for in- and outdoor use has a very elegant design, has no visible lens, is weatherproof (IP52) and is very subtle thanks to its 73 x 30 mm dimensions. The white Motivity Plus (KNX\_MOTPLUS\_W) has a built-in brightness and temperature sensor on top of its motion detecting capabilities, where the black Motivity Plus (KNX\_MOTPLUS\_B) supports motion and temperature sensing. The 12V DC motion detector exists in white (NOC\_MOTPLUS\_W) and black (NOC\_MOTPLUS\_B) and only supports motion detection.



ACCESSORIES

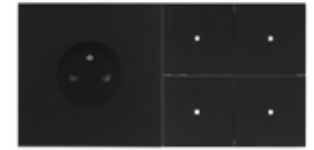

BCU\_EBSS02  
Wallbox for placing switch and socket aligned

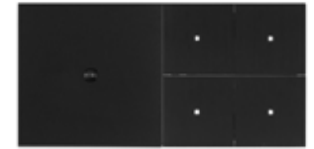

BCU\_EBSM02  
Wallbox for placing switch and motivity wall aligned



BCU\_EBSS03  
Wallbox for placing switch and 2F socket aligned

TRIM\_SOCK6MMMCW1\_BC  
Bronze  
SOCK6MMRB1  
Bronze

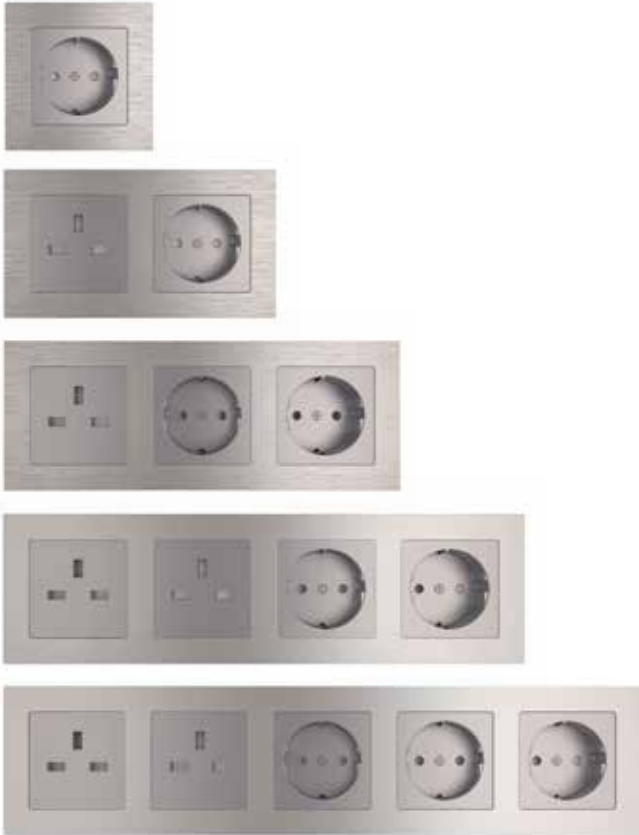

SQUARE 12mm  
 55x55 insert Jung, Berker, Gira, ...  
 All finishes  
 Glass, Stone and Wooden 4F & 5F frames available on request.

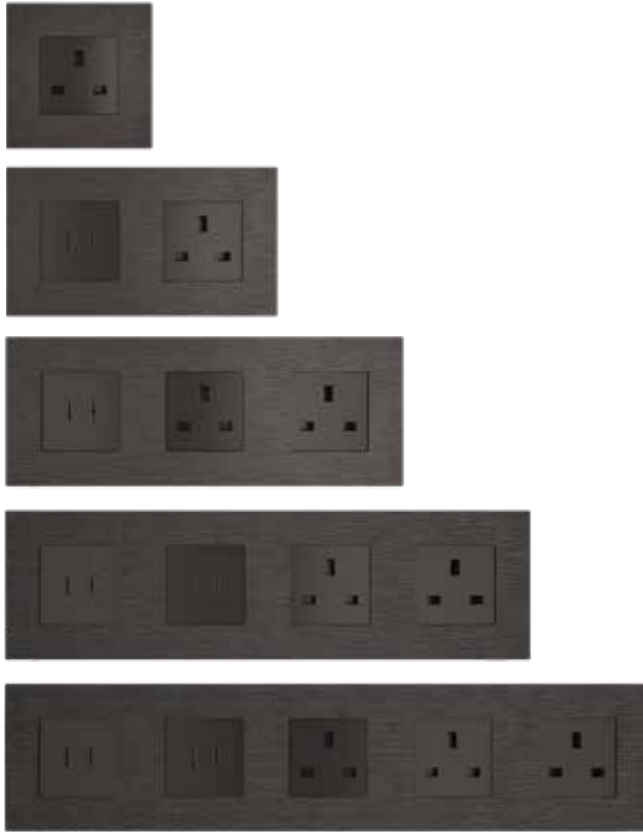

SQUARE 6mm  
 45x45 insert Legrand Arteor/Mosaic/Valena Next , Peha Concept 45 ,  
 Simon K45 , Hager  
 All metals

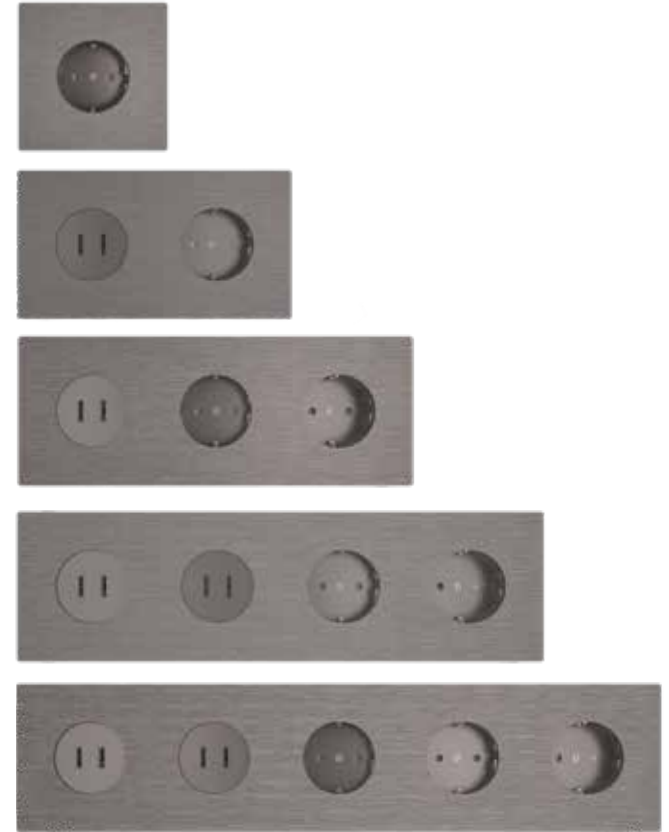

ROUND 6mm  
 45x45 insert Legrand Arteor/Mosaic/Valena Next , Peha Concept 45 ,  
 Simon K45 , Hager  
 All metals  
 Not for British Standard insert nor double RJ45



## Socket frames

Use single German Standard or single British Standard wall boxes for all our different types of socket plates. Try out the wallboxes in combination with our socket frames before you start the installation.

Distance between the center points is 71 mm.

Inserts not included.

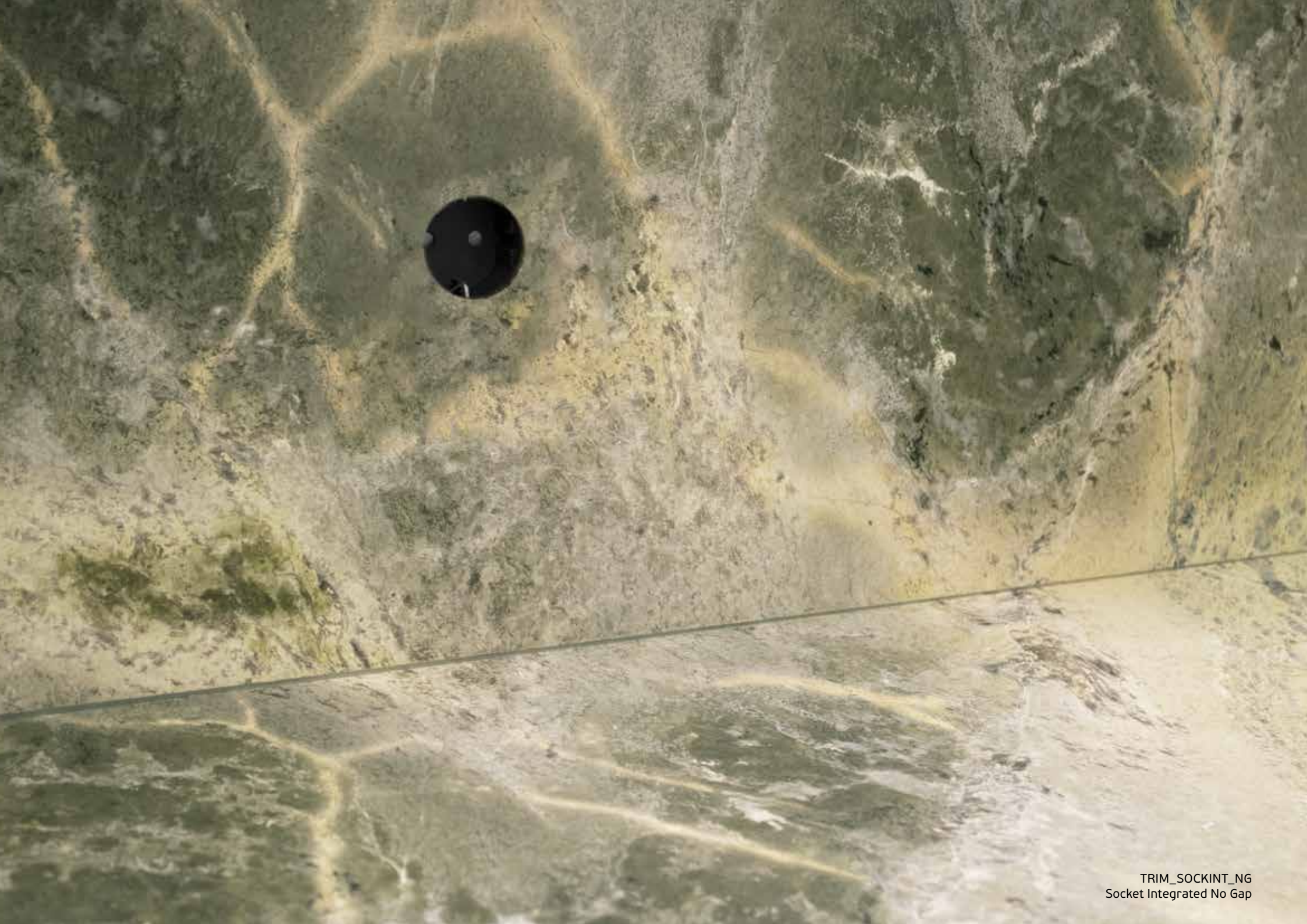

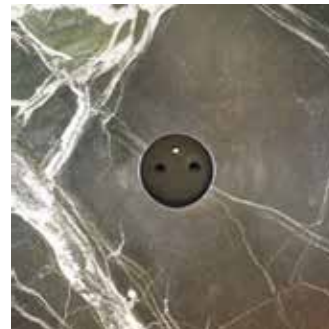
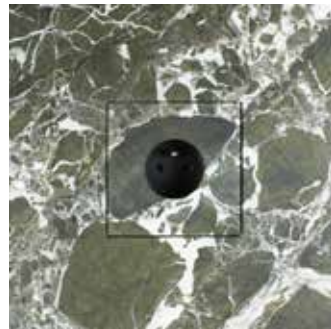

TRIM SOCKINT\_WG  
Integrated With Gap - 1,25 mm gap



TRIM SOCKINT\_NG  
Integrated No Gap



TRIM SOCKRJ45INT\_WG  
Integrated With Gap - 1,25 mm gap



## Socket Integrated

Tense can now provide you with special wallboxes to be placed behind Painted Glass, Corian®, Stone, Ceramic, Terrazzo, MDF or Wooden wall to create fully integrated sockets. In addition, a shaver socket is also available.

This way a foolproof installation of any integrated single or double socket is possible: with gap or without gap.

Furthermore, we can guide you with the instructions and dimensions regarding the cut-out at the backside of these materials.



## Plasterboard wall (12,5 mm)



Cut a hole in the wall and install 2 wooden planks (dimensions: see technical data sheet)

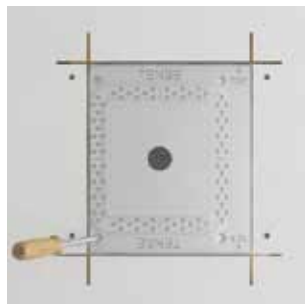

Screw the fixture on the wooden planks by using 4 screws

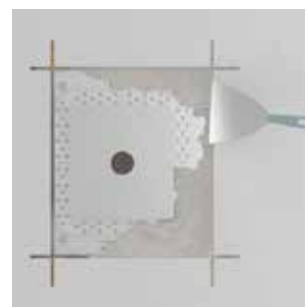

Add fibreglass netting and plaster up to the rounded second level



Smoothen with a sanding machine



Paint the wall

55x55 insert Jung, Berker, Gira, ...  
 45x45 insert Niko (with special adapter)  
 Inserts not included



## Brick/Concrete wall (6 mm)

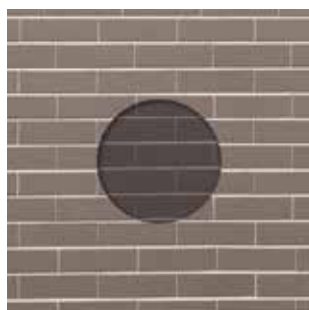

Drill a hole in the wall (dimensions: see technical data sheet)



Screw the fixture on the wall by using 4 plugs and screws

# Invisible Socket

This innovative recessed Invisible Socket is fast to install (glued or screwed via pre-drilled screw holes/large mounting surface to easily adjust) and easy to plaster thanks to the rounded second level in the Xillo fixture. The Invisible Socket meets the highest finishing standards, is available in 6 mm and 12,5 mm thickness, and exists in a single and double version.





## Plasterboard wall (12,5 mm)



Cut a hole in the wall and install 2 wooden planks (dimensions: see technical data sheet)

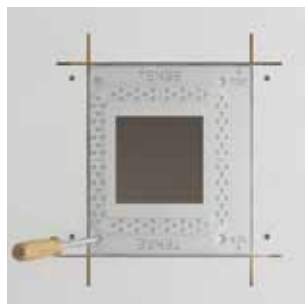

Screw the fixture on the wooden planks by using 4 screws

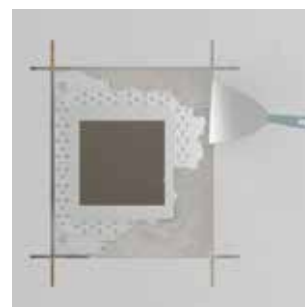

Add fiberglass netting and plaster up to the rounded second level

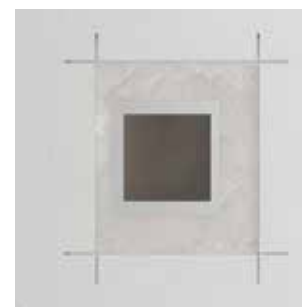

Smoothen with a sanding machine

## Brick/Concrete wall (6 mm)

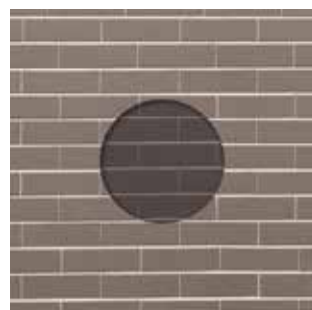

Drill a hole in the wall (dimensions: see technical data sheet)



Screw the fixture on the wall by using 4 plugs and screws



SOCK6MMRP1  
 TRIM SOCK6MMMCW1  
 45x45 insert Peha Concept 45 ,  
 Legrand Arteor/Mosaic/Valena Next ,  
 Simon K45 , Hager



SOCK6MMSP1  
 TRIM SOCK6MMMCW1  
 45x45 insert Peha Concept 45,  
 Legrand Arteor/Mosaic/Valena Next,  
 Simon K45 , Hager



Paint the wall and the sockets.  
 Spray a matte water-based  
 varnish on the socket to protect  
 it and make it cleanable.  
 Inserts not included.

# Paintable Socket

The Paintable Socket meets the highest finishing standards, and are suitable for all types of paints. The single or double Paintable Socket is available with a round or a square opening, surely matching the project.

The Trimless wall box needs to be ordered separately. The wall box is both easy to install (glued or screwed via pre-drilled screw holes/large mounting surface to easily adjust) as well as easy to plaster thanks to the rounded second level in the Xillo fixture. The wall box is available in 6mm and 12,5mm thickness.



2 VERSIONS  
USB-C  
Lightning



Install the special double wall box without separation (included) vertically on the wall and fix the Eyeswitch Intensity into place.



Slide the supporting bracket into place and adjust the height of the connector accordingly to the iPad type.



Mount the iPad by sliding and clicking it into the connector.



The iPad is now ready to use in your home automation.

## Eyeswitch

This handy universal iPad mount (EYE\_INT...) with integrated charger is combined with an 8 fold Intensity switch. You can adjust the height of the connector according to your iPad type. In a few seconds, your iPad becomes wall-mounted. Thanks to the Intensity switch, you can directly operate your home automation, even when the iPad is not present. If necessary, it is very easy to demount the iPad and supporting bracket while maintaining a sleek designer look thanks to the Intensity 8 fold switch. This product is available with a USB-C or Lightning connector in all metal finishes..

For the lightning connector version, a direct LAN kit is available (EYE\_LAN\_KIT\_L).





## Hotelswitch

The Intensity switch, specially designed as a hotel solution, contains four touch zones. Each of the 4 logos on the switch act as a touch zone with each logo being a RGB LED light.

This switch is available in Glass White and Glass Black. These finishes are printed and do not use the silk screen technique as our other glass products. Slight colour variations may occur in comparison with our other glass products.

Logo's, numbers and symbols can be personalised through the **printing process**. The room number in the center does not highlight. No cardreader included.

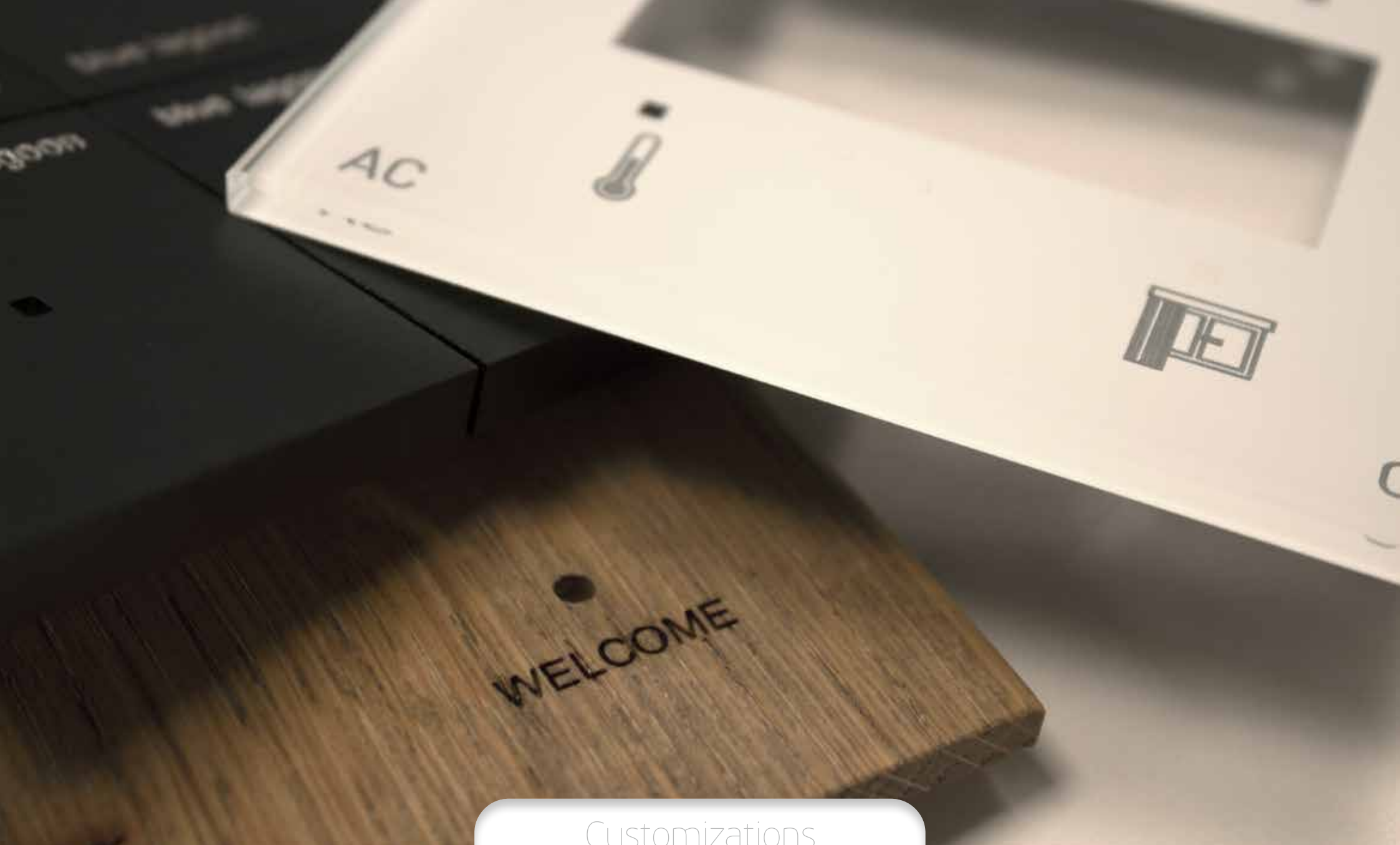

## Customizations

Would you like to personalize your products permanently with inscriptions, logos and/or symbols?

All Tense finishes are suitable for lasering, engraving and/or printing.

Special request? Looking for a unique piece? Tense is able to **customize your products or ideas** in order to obtain a uniform look throughout your project.

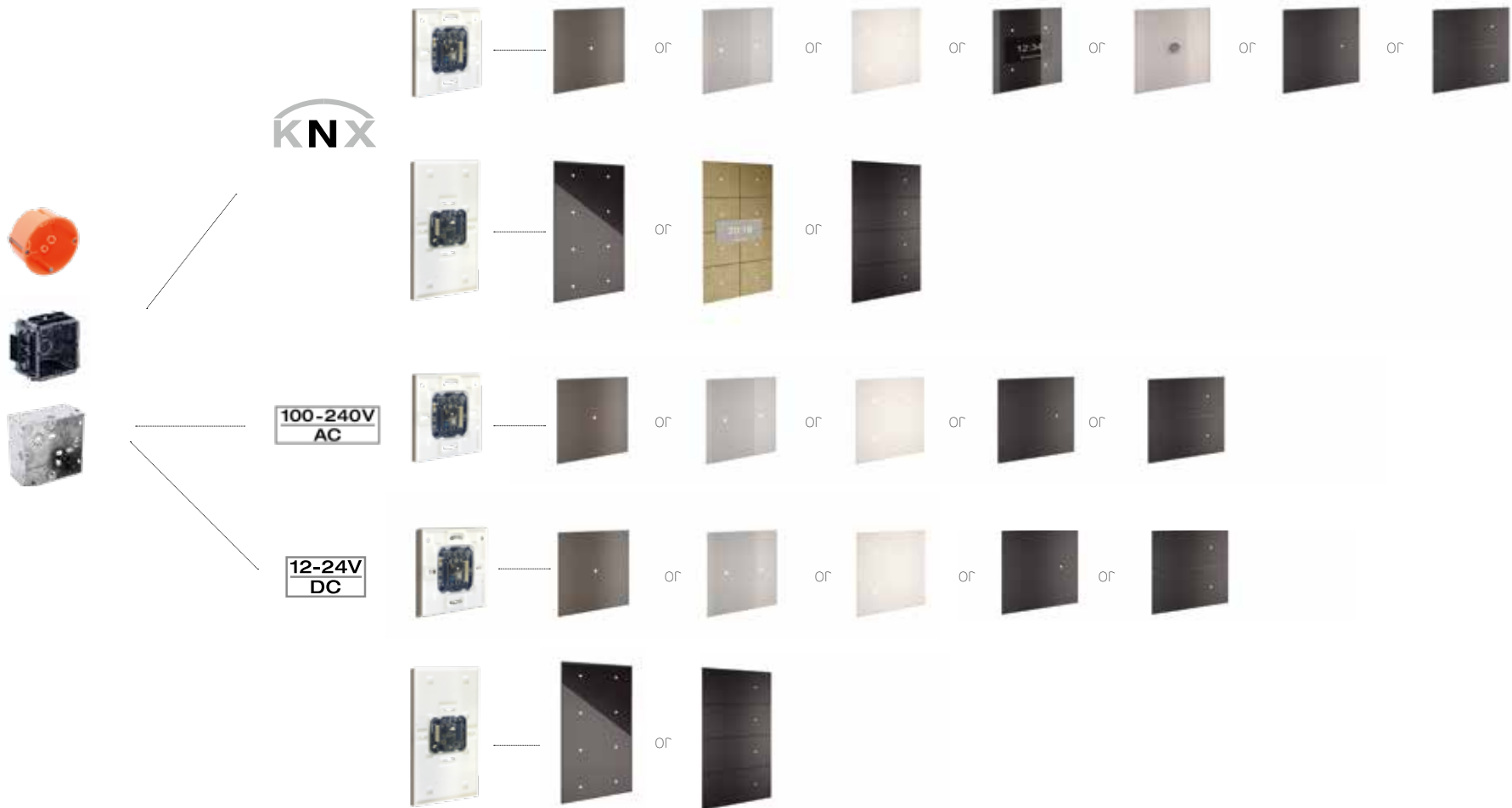

## Installation & Maintenance

Tense products can be installed in a single round or square European Standard or British Standard wall mounting box. Use flat headed screws to fix the BCU to the wall.  
 For the 8 fold Intensity switch, 8 fold Infinity room controller and the 4 fold Intensity Landscape, only one single wall box is needed.  
 All Tense switches are to be cleaned with non-aggressive, non-solvent based cleaners.

Marketing Case



Marketing Box



Integrated Display



## Marketing tools

Marketing Case Premium (MAR\_CASE\_PREM): this case can be connected to the mains or to your KNX system and enables your customer/architect to touch, feel and experience 6 functioning KNX Intensity switches and 1 KNX Infinity switch. Furthermore, the demo case contains a sample of nearly all Tense products, versions and materials.

Marketing Box (MAR\_BOX): this handy box contains the standard material range in 24 handy demo plates of 42\*42mm and one demo plate of 84\*84mm.

Integrated Display (MAR\_INT): a handy display with different mounting pieces which can be used to show the workings of all Tense Integrated products.



INTAW4  
Alu White

TRIM\_SWITCHMCWINV124\_P  
Trimless switch Metal Corian Wood Invisible, 1, 2, 4F Plasterboard Wall



## Plasterboard wall (12,5 mm)



Cut a hole in the wall and install 2 wooden planks (dimensions: see technical data sheet)

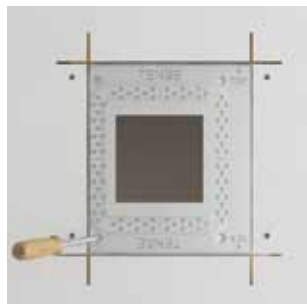

Screw the fixture on the wooden planks by using 4 screws

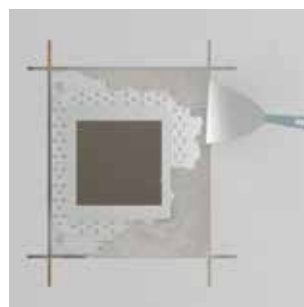

Add fiberglass netting and plaster up to the rounded second level

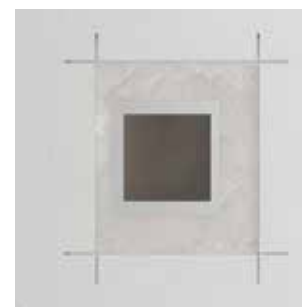

Smoothen with a sanding machine



Paint the wall

## Brick/Concrete wall (6 mm)

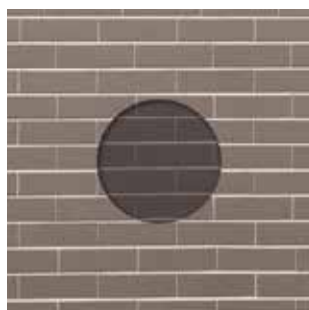

Drill a hole in the wall (dimensions: see technical data sheet)



Screw the fixture on the wall by using 4 plugs and screws

# Trimless 100% recessed

Almost all Tense products can be flush-mounted in the strong, plasterable and paintable Xillo composite fixture.

This innovative recessed solution is fast to install and easy to plaster thanks to the handy indicators and layer design on the fixture.

Xillo meets the highest finishing standards and is suitable for all surfaces (plasterboard - 12,5 mm and brick/concrete - 6 mm) which creates a recessed look in every project.



Recessed Ventilation



Recessed Toilet Flush Button



Recessed Smoke detector

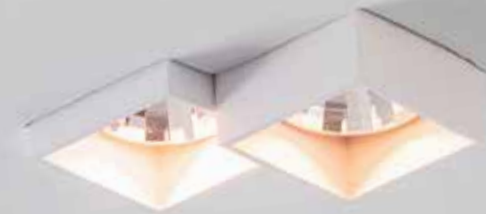

Adjustable lighting

XILLO

INNOVATIVE RECESSED SOLUTIONS

[www.xillo.be](http://www.xillo.be)



Recessed lighting



Trimless LED Profiles



Recessed Intrusion detector

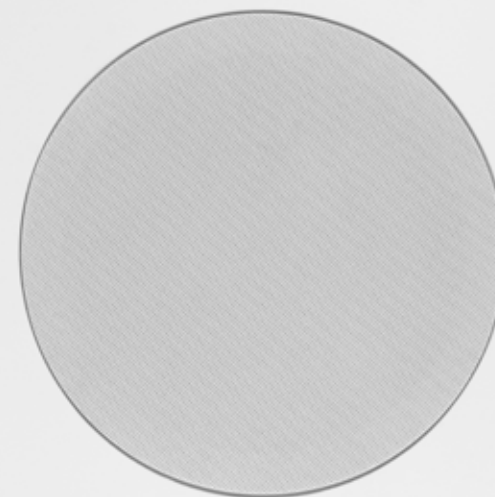

Recessed Audio



Recessed Wall Lighting

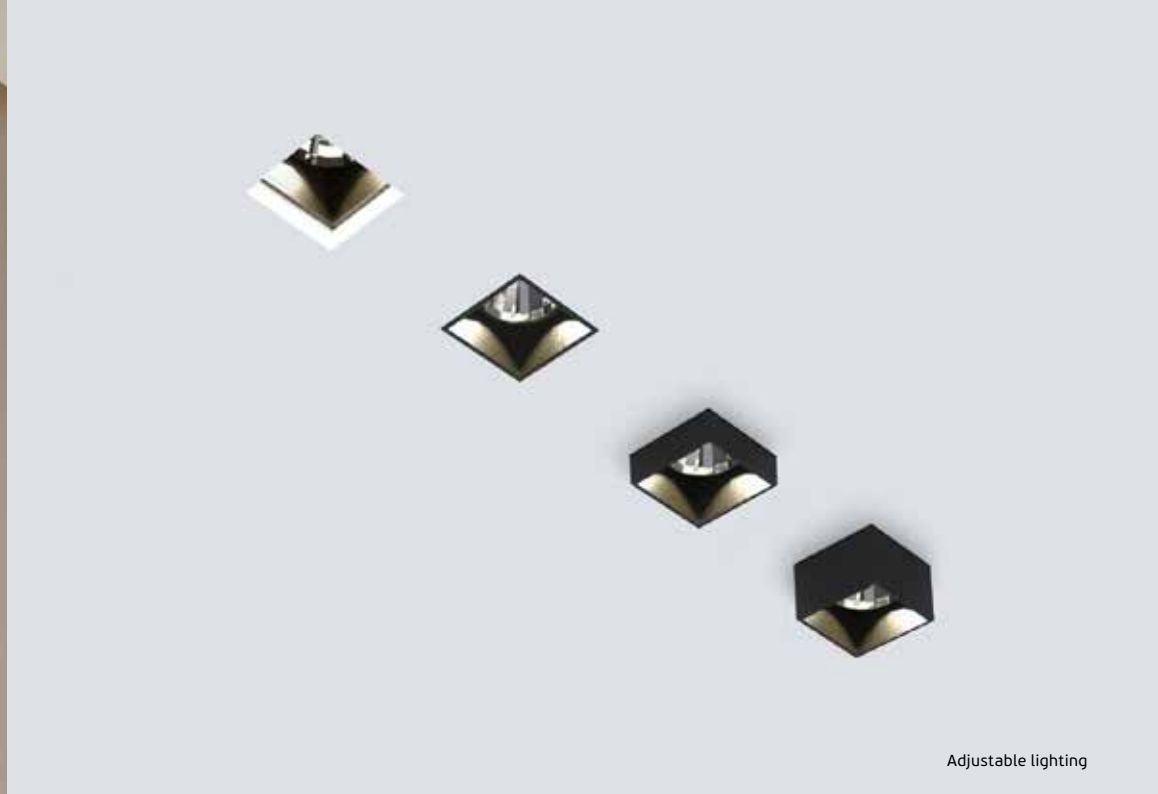

Adjustable lighting



Code Keypad



KNX\_KNX\_CODE  
 12-24V DC\_NOC\_CODE  
 100-240V AC\_RET\_CODE  
 DEMO\_DEM\_CODE  
 FRONT\_FRQ\_CODE

ALU	FORGED ALU	ALU BLACK	FORGED ALU BLACK	ALU DARK GREY	FORGED ALU DARK GREY	ALU WHITE	ALU RAL SPECIAL	DIMENSIONS (mm)
-----	------------	-----------	------------------	---------------	----------------------	-----------	-----------------	-----------------

INTENSITY switch										
	1F	INTA1	INTFA1	INTAB1	INTFAB1	INTADG1	INTFADG1	INTAW1	INTARAL1	84 x 84 x 6
	2F	INTA2	INTFA2	INTAB2	INTFAB2	INTADG2	INTFADG2	INTAW2	INTARAL2	84 x 84 x 6
	4F	INTA4	INTFA4	INTAB4	INTFAB4	INTADG4	INTFADG4	INTAW4	INTARAL4	84 x 84 x 6
	8F	INTA8	INTFA8	INTAB8	INTFAB8	INTADG8	INTFADG8	INTAW8	INTARAL8	165 x 84 x 6

































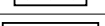
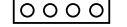

INTENSITY LANDSCAPE switch										
	1F	INTLA1	INTLFA1	INTLAB1	INTLFAB1	INTLADG1	INTLFADG1	INTLAW1	INTLARAL1	84 x 84 x 6
	2F	INTLA2	INTLFA2	INTLAB2	INTLFAB2	INTLADG2	INTLFADG2	INTLAW2	INTLARAL2	84 x 84 x 6
	4F	INTLA4	INTLFA4	INTLAB4	INTLFAB4	INTLADG4	INTLFADG4	INTLAW4	INTLARAL4	165 x 84 x 6

Serenity switch										
	1F	SERA1	SERFA1	SERAB1	SERFAB1	SERADG1	SERFADG1	SERAW1	SERARAL1	84 x 84 x 6
	2F	SERA2	SERFA2	SERAB2	SERFAB2	SERADG2	SERFADG2	SERAW2	SERARAL2	84 x 84 x 6
	4F	SERA4	SERFA4	SERAB4	SERFAB4	SERADG4	SERFADG4	SERAW4	SERARAL4	84 x 84 x 6

Velocity switch										
	1F	VELA1	VELFA1	VELAB1	VELFAB1	VELADG1	VELFADG1	VELAW1	VELARAL1	84 x 84 x 6
	2F	VELA2	VELFA2	VELAB2	VELFAB2	VELADG2	VELFADG2	VELAW2	VELARAL2	84 x 84 x 6
	4F	VELA4	VELFA4	VELAB4	VELFAB4	VELADG4	VELFADG4	VELAW4	VELARAL4	84 x 84 x 6

INFINITY room controller (KNX only)										
	OLED 4F	INFA4	INFFA4	INFAB4	INFFAB4	INFADG4	INFFADG4	INFAW4	INFARAL4	84 x 84 x 9
	OLED 8F	INFA8	INFFA8	INFAB8	INFFAB8	INFADG8	INFFADG8	INFAW8	INFARAL8	165 x 84 x 9

KNX: KNX\_CODE  
 12-24V DC: NDC\_CODE  
 100-240V AC: RETL\_CODE  
 DEMO: DEM\_CODE  
 FRONT: FRG\_CODE

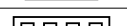



		ALU	FORGED ALU	ALU BLACK	FORGED ALU BLACK	ALU DARK GREY	FORGED ALU DARK GREY	ALU WHITE	ALU RAL SPECIAL	DIMENSIONS (mm)
SOCKET frame 12mm 55 x 55 mm		 schuko	 be/fr	 1xRJ45	 usb a/r	 coax	 2xRJ45	 uk	...	
	1F	SOCKA1	SOCKFA1	SOCKAB1	SOCKFAB1	SOCKADF1	SOCKFADG1	SOCKAW1	SOCKARAL1	84 x 84 x 12
	2F	SOCKA2	SOCKFA2	SOCKAB2	SOCKFAB2	SOCKADG2	SOCKFADG2	SOCKAW2	SOCKARAL2	155 x 84 x 12
	3F	SOCKA3	SOCKFA3	SOCKAB3	SOCKFAB3	SOCKADG3	SOCKFADG3	SOCKAW3	SOCKARAL3	226 x 84 x 12
	4F	SOCKA4	SOCKFA4	SOCKAB4	SOCKFAB4	SOCKADG4	SOCKFADG4	SOCKAW4	SOCKARAL4	297 x 84 x 12
	5F	SOCKA5	SOCKFA5	SOCKAB5	SOCKFAB5	SOCKADG5	SOCKFADG5	SOCKAW5	SOCKARAL5	368 x 84 x 12
SOCKET frame 6mm round 45 x 45 mm		 schuko	 be/fr	 1xRJ45	 usb a/r	 coax	 2xRJ45	 uk	...	
	1F	SOCK6MMRA1	SOCK6MMRFA1	SOCK6MMRAB1	SOCK6MMRFAB1	SOCK6MMRADF1	SOCK6MMRFADG1	SOCK6MMRAW1	SOCK6MMRARAL1	84 x 84 x 6
	2F	SOCK6MMRA2	SOCK6MMRFA2	SOCK6MMRAB2	SOCK6MMRFAB2	SOCK6MMRADG2	SOCK6MMRFADG2	SOCK6MMRAW2	SOCK6MMRARAL2	155 x 84 x 6
	3F	SOCK6MMRA3	SOCK6MMRFA3	SOCK6MMRAB3	SOCK6MMRFAB3	SOCK6MMRADG3	SOCK6MMRFADG3	SOCK6MMRAW3	SOCK6MMRARAL3	226 x 84 x 6
	4F	SOCK6MMRA4	SOCK6MMRFA4	SOCK6MMRAB4	SOCK6MMRFAB4	SOCK6MMRADG4	SOCK6MMRFADG4	SOCK6MMRAW4	SOCK6MMRARAL4	297 x 84 x 6
	5F	SOCK6MMRA5	SOCK6MMRFA5	SOCK6MMRAB5	SOCK6MMRFAB5	SOCK6MMRADG5	SOCK6MMRFADG5	SOCK6MMRAW5	SOCK6MMRARAL5	368 x 84 x 6
SOCKET frame 6mm square 45 x 45 mm		 schuko	 be/fr	 1xRJ45	 usb a/r	 coax	 2xRJ45	 uk	...	
	1F	SOCK6MMSA1	SOCK6MMSFA1	SOCK6MMSAB1	SOCK6MMSFAB1	SOCK6MMSADF1	SOCK6MMSFADG1	SOCK6MMSAW1	SOCK6MMSARAL1	84 x 84 x 6
	2F	SOCK6MMSA2	SOCK6MMSFA2	SOCK6MMSAB2	SOCK6MMSFAB2	SOCK6MMSADG2	SOCK6MMSFADG2	SOCK6MMSAW2	SOCK6MMSARAL2	155 x 84 x 6
	3F	SOCK6MMSA3	SOCK6MMSFA3	SOCK6MMSAB3	SOCK6MMSFAB3	SOCK6MMSADG3	SOCK6MMSFADG3	SOCK6MMSAW3	SOCK6MMSARAL3	226 x 84 x 6
	4F	SOCK6MMSA4	SOCK6MMSFA4	SOCK6MMSAB4	SOCK6MMSFAB4	SOCK6MMSADG4	SOCK6MMSFADG4	SOCK6MMSAW4	SOCK6MMSARAL4	297 x 84 x 6
	5F	SOCK6MMSA5	SOCK6MMSFA5	SOCK6MMSAB5	SOCK6MMSFAB5	SOCK6MMSADG5	SOCK6MMSFADG5	SOCK6MMSAW5	SOCK6MMSARAL5	368 x 84 x 6
MOTIVITY WALL detector		MOTA	MOTFA	MOTAB	MOTFAB	MOTADG	MOTFADG	MOTAW	MOTARAL	84 x 84 x 6
EYESWITCH LIGHTNING*		EYEINTAB_L	EYEINTFAB_L	EYEINTAB8_L	EYEINTFAB8_L	EYEINTADG8_L	EYEINTFADG8_L	EYEINTAW8_L	EYEINTARAL8_L	182 x 320 x 14
EYESWITCH USB-C**		EYEINTAB_C	EYEINTFAB_C	EYEINTAB8_C	EYEINTFAB8_C	EYEINTADG8_C	EYEINTFADG8_C	EYEINTAW8_C	EYEINTARAL8_C	182 x 320 x 14



\* Power supply is included in the product LAN connection kit (EYE\_LAN\_KIT\_L) has to be ordered separately.



\*\* Power supply is included in the product LAN connection kit (EYE\_LAN\_KIT) is not available.

KNX: KNX\_CODE  
 12-24V DC: NOC\_CODE  
 100-240V AC: RET\_CODE  
 DEMO: DEM\_CODE  
 FRONT: FRO\_CODE



BRONZE	FORGED BRONZE	BRONZE LIGHT	BRUSHED GOLD	FORGED GOLD	BRUSHED COPPER ROSE	FORGED COPPER ROSE	CHROME	STAINLESS STEEL	FORGED STAINLESS STEEL	FORGED STEEL	DIMENSIONS (mm)
--------	---------------	--------------	--------------	-------------	---------------------	--------------------	--------	-----------------	------------------------	--------------	-----------------

INTENSITY switch													
	1F	INTB1	INTFB1	INTBL1	INTBG1	INTFG1	INTBCR1	INTFCR1	INTCH1	INTSS1	INTFSS1	INTFS1	84 x 84 x 6
	2F	INTB2	INTFB2	INTBL2	INTBG2	INTFG2	INTBCR2	INTFCR2	INTCH2	INTSS2	INTFSS2	INTFS2	84 x 84 x 6
	4F	INTB4	INTFB4	INTBL4	INTBG4	INTFG4	INTBCR4	INTFCR4	INTCH4	INTSS4	INTFSS4	INTFS4	84 x 84 x 6
	8F	INTB8	INTFB8	INTBL8	INTBG8	INTFG8	INTBCR8	INTFCR8	INTCH8	INTSS8	INTFSS8	INTFS8	165 x 84 x 6

INTENSITY LANDSCAPE switch													
	1F	INTLB1	INTLFB1	INTLBL1	INTLBG1	INTLFG1	INTLBCR1	INTLFCR1	INTLCH1	INTLSS1	INTLFSS1	INTLFS1	84 x 84 x 6
	2F	INTLB2	INTLFB2	INTLBL2	INTLBG2	INTLFG2	INTLBCR2	INTLFCR2	INTLCH2	INTLSS2	INTLFSS2	INTLFS2	84 x 84 x 6
	4F	INTLB4	INTLFB4	INTLBL4	INTLBG4	INTLFG4	INTLBCR4	INTLFCR4	INTLCH4	INTLSS4	INTLFSS4	INTLFS4	165 x 84 x 6

















SERENITY switch													
	1F	SERB1	SERFB1	SERBL1	SERBG1	SERFG1	SERBCR1	SERFCR1	SERCH1	SERSS1	SERFSS1	SERFS1	84 x 84 x 6
	2F	SERB2	SERFB2	SERBL2	SERBG2	SERFG2	SERBCR2	SERCR2	SERCH2	SERSS2	SERFSS2	SERFS2	84 x 84 x 6
	4F	SERB4	SERFB4	SERBL4	SERBG4	SERFG4	SERBCR4	SERCR4	SERCH4	SERSS4	SERFSS4	SERFS4	165 x 84 x 6

Velocity switch													
	1F	VELB1	VELFB1	VELBL1	VELBG1	VELFG1	VELBCR1	VELFCR1	VELCH1	VELSS1	VELFSS1	VELFS1	84 x 84 x 6
	2F	VELB2	VELFB2	VELBL2	VELBG2	VELFG2	VELBCR2	VELFCR2	VELCH2	VELSS2	VELFSS2	VELFS2	84 x 84 x 6
	4F	VELB4	VELFB4	VELBL4	VELBG4	VELFG4	VELBCR4	VELFCR4	VELCH4	VELSS4	VELFSS4	VELFS4	84 x 84 x 6

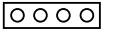
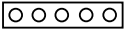
INFINITY room controller (KNX only)													
	OLED 4F	INFA4	INFFA4	INFAB4	INFFAB4	INFADG4	INFFADG4	INFAW4	INFARAL4	INFFADG4	INFAW4	INFARAL4	84 x 84 x 9
	OLED 8F	INFAB8	INFFAB8	INFAB8	INFFAB8	INFADG8	INFFADG8	INFAW8	INFARAL8	INFFADG8	INFAW8	INFARAL8	165 x 84 x 9



KNX KNX\_CODE  
 12-24V DC NOC\_CODE  
 100-240V AC RET\_CODE  
 DEMO DEM\_CODE  
 FRONT: FRO\_CODE

		BRONZE	FORGED BRONZE	BRONZE LIGHT	FORGED BRONZE LIGHT	BRUSHED GOLD	FORGED GOLD	BRUSHED COPPER ROSE	FORGED COPPER ROSE	CHROME	STAINLESS STEEL	FORGED STAINLESS STEEL	FORGED STEEL	DIMENSIONS (mm)	
SOCKET frame 12mm 55 x 55 mm															
	1F	SOCKB1	SOCKFB1	SOCKBL1	SOCKFBL1	SOCKBG1	SOCKFG1	SOCKBCR1	SOCKFCR1	SOCKCH1	SOCKSS1	SOCKFSS1	SOCKFS1	84 x 84 x 12	
	2F	SOCKB2	SOCKFB2	SOCKBL2	SOCKFBL2	SOCKBG2	SOCKFG2	SOCKBCR2	SOCKFCR2	SOCKCH2	SOCKSS2	SOCKFSS2	SOCKFS2	155 x 84 x 12	
	3F	SOCKB3	SOCKFB3	SOCKBL3	SOCKFBL3	SOCKBG3	SOCKFG3	SOCKBCR3	SOCKFCR3	SOCKCH3	SOCKSS3	SOCKFSS3	SOCKFS3	226 x 84 x 12	
	4F	SOCKB4	SOCKFB4	SOCKBL4	SOCKFBL4	SOCKBG4	SOCKFG4	SOCKBCR4	SOCKFCR4	SOCKCH4	SOCKSS4	SOCKFSS4	SOCKFS4	297 x 84 x 12	
	5F	SOCKB5	SOCKFB5	SOCKBL5	SOCKFBL5	SOCKBG5	SOCKFG5	SOCKBCR5	SOCKFCR5	SOCKCH5	SOCKSS5	SOCKFSS5	SOCKFS5	368 x 84 x 12	
SOCKET frame 6mm round 45 x 45 mm															
	1F	SOCK6MMRB1	SOCK6MMRFB1	SOCK6MMRBL1	SOCK6MMRFBL1	SOCK6MMRBG1	SOCK6MMRFG1	SOCK6MMRBCR1	SOCK6MMRFCR1	SOCK6MMRCH1	SOCK6MMRSS1	SOCK6MMRFSS1	SOCK6MMRFS1	84 x 84 x 6	
	2F	SOCK6MMRB2	SOCK6MMRFB2	SOCK6MMRBL2	SOCK6MMRFBL2	SOCK6MMRBG2	SOCK6MMRFG2	SOCK6MMRBCR2	SOCK6MMRFCR2	SOCK6MMRCH2	SOCK6MMRSS2	SOCK6MMRFSS2	SOCK6MMRFS2	155 x 84 x 6	
	3F	SOCK6MMRB3	SOCK6MMRFB3	SOCK6MMRBL3	SOCK6MMRFBL3	SOCK6MMRBG3	SOCK6MMRFG3	SOCK6MMRBCR3	SOCK6MMRFCR3	SOCK6MMRCH3	SOCK6MMRSS3	SOCK6MMRFSS3	SOCK6MMRFS3	226 x 84 x 6	
	4F	SOCK6MMRB4	SOCK6MMRFB4	SOCK6MMRBL4	SOCK6MMRFBL4	SOCK6MMRBG4	SOCK6MMRFG4	SOCK6MMRBCR4	SOCK6MMRFCR4	SOCK6MMRCH4	SOCK6MMRSS4	SOCK6MMRFSS4	SOCK6MMRFS4	297 x 84 x 6	
	5F	SOCK6MMRB5	SOCK6MMRFB5	SOCK6MMRBL5	SOCK6MMRFBL5	SOCK6MMRBG5	SOCK6MMRFG5	SOCK6MMRBCR5	SOCK6MMRFCR5	SOCK6MMRCH5	SOCK6MMRSS5	SOCK6MMRFSS5	SOCK6MMRFS5	368 x 84 x 6	
SOCKET frame 6mm square 45 x 45 mm															
	1F	SOCK6MMSB1	SOCK6MMSFB1	SOCK6MMSBL1	SOCK6MMSFBL1	SOCK6MMSBG1	SOCK6MMSFG1	SOCK6MMSBCR1	SOCK6MMSFCR1	SOCK6MMSCH1	SOCK6MMSSS1	SOCK6MMSFSS1	SOCK6MMSFS1	84 x 84 x 6	
	2F	SOCK6MMSB2	SOCK6MMSFB2	SOCK6MMSBL2	SOCK6MMSFBL2	SOCK6MMSBG2	SOCK6MMSFG2	SOCK6MMSBCR2	SOCK6MMSFCR2	SOCK6MMSCH2	SOCK6MMSSS2	SOCK6MMSFSS2	SOCK6MMSFS2	155 x 84 x 6	
	3F	SOCK6MMSB3	SOCK6MMSFB3	SOCK6MMSBL3	SOCK6MMSFBL3	SOCK6MMSBG3	SOCK6MMSFG3	SOCK6MMSBCR3	SOCK6MMSFCR3	SOCK6MMSCH3	SOCK6MMSSS3	SOCK6MMSFSS3	SOCK6MMSFS3	226 x 84 x 6	
	4F	SOCK6MMSB4	SOCK6MMSFB4	SOCK6MMSBL4	SOCK6MMSFBL4	SOCK6MMSBG4	SOCK6MMSFG4	SOCK6MMSBCR4	SOCK6MMSFCR4	SOCK6MMSCH4	SOCK6MMSSS4	SOCK6MMSFSS4	SOCK6MMSFS4	297 x 84 x 6	
	5F	SOCK6MMSB5	SOCK6MMSFB5	SOCK6MMSBL5	SOCK6MMSFBL5	SOCK6MMSBG5	SOCK6MMSFG5	SOCK6MMSBCR5	SOCK6MMSFCR5	SOCK6MMSCH5	SOCK6MMSSS5	SOCK6MMSFSS5	SOCK6MMSFS5	368 x 84 x 6	
MOTIVITY WALL detector		MOTB	MOTFB	MOTBL	MOTFBL	MOTBG	MOTFG	MOTBCR	MOTFCR	MOTCH	MOTSS	MOTFSS	MOTFS	84 x 84 x 6	
EYESWITCH LIGHTNING*		EYEINTB8_L	EYEINTFB8_L	EYEINTBL8_L	EYEINTFBL8_L	EYEINTB8_C	EYEINTFG8_C	EYEINTBCR8_C	EYEINTFCR8_C	EYEINTCH8_C	EYEINTSS8_C	EYEINTFSS8_C	EYEINTFS8_C	182 x 320 x 14	
EYESWITCH USB-C**		EYEINTB8_C	EYEINTFB8_C	EYEINTBL8_C	EYEINTFBL8_C	EYEINTB8_C	EYEINTFG8_C	EYEINTBCR8_C	EYEINTFCR8_C	EYEINTCH8_C	EYEINTSS8_C	EYEINTFSS8_C	EYEINTFS8_C	182 x 320 x 14	

\* Power supply is included in the product LAN connection kit (EYE\_LAN\_KIT\_L) has to be ordered separately.  
 \*\* Power supply is included in the product. LAN connection kit (EYE\_LAN\_KIT) is not available.

KNX: KNX\_CODE  
 12-24V DC: NOC\_CODE  
 100-240V AC: RET\_CODE  
 DEMO: DEM\_CODE  
 FRONT: FRO\_CODE

GLASS WHITE	GLASS BLACK	GLASS SILVER	DIMENSIONS (mm)
-------------	-------------	--------------	-----------------

CORIAN® WHITE	CORIAN® BLACK	CORIAN® CARREA WHITE	CORIAN® LINEA WHITE	CORIAN® ORGANICA WHITE	CORIAN® RONDA WHITE	CORIAN® CLAUDA WHITE	CORIAN® RAL	DIMENSIONS (mm)
---------------	---------------	----------------------	---------------------	------------------------	---------------------	----------------------	-------------	-----------------

INTENSITY switch					
	1F	INTGW1	INTGB1	INTGS1*	90 x 90 x 8
	2F	INTGW2	INTGB2	X	90 x 90 x 8
	4F	INTGW4	INTGB4	INTGS4*	90 x 90 x 8
	8F	INTGW8	INTGB8	INTGS8*	160 x 90 x 8
	1F	X	X	X	X
	2F	X	X	X	X
	4F	X	X	X	X
	HOTEL	INTHW4	INTHGB4	X	90 x 90 x 13,5

INTCW1	INTCB1	X	X	X	X	X	INTCRAL1	84 x 84 x 6
INTCW2	INTCB2	X	X	X	X	X	INTCRAL2	84 x 84 x 6
INTCW4	INTCB4	INTCCAW4	INTCLW4	INTCORW4	INTCROW4	INTCCLW4	INTCRAL4	84 x 84 x 6
INTCW8	INTCB8	X	X	X	X	X	INTCRAL8	165 x 84 x 6
X	X	X	X	X	X	X	X	X
X	X	X	X	X	X	X	X	X
X	X	X	X	X	X	X	X	X
X	X	X	X	X	X	X	X	X

INFINITY room controller (KNX only)					
	OLED 4F	INFGW4	INFGB4	X	90 x 90 x 10
	OLED 8F	X	X	X	X

INFCW4	INFCB4	X	X	X	X	X	INFCRAL4	84 x 84 x 9
INFCW8	INFCB8	X	X	X	X	X	INFCRAL8	165 x 84 x 9

SOCKET frame 12mm 55 x 55 mm							
	1F	SOCKGW1	SOCKGB1	X	90 x 90 x 10,5		
	2F	SOCKGW2	SOCKGB2	SOCKGS2*	161 x 90 x 10,5		
	3F	SOCKGW3	SOCKGB3	SOCKGS3*	232 x 90 x 10,5		
	4F	On request	On request	X	303 x 90 x 10,5		
	5F	X	X	X	X		

SOCKET frame 12mm 55 x 55 mm								
SOCKCW1	SOCKCB1	X	X	X	X	X	SOCKRAL1	84 x 84 x 12
SOCKCW2	SOCKCB2	X	X	X	X	X	SOCKRAL2	155 x 84 x 12
SOCKCW3	SOCKCB3	X	X	X	X	X	SOCKRAL3	226 x 84 x 12
SOCKCW4	SOCKCB4	X	X	X	X	X	SOCKRAL4	297 x 84 x 12
SOCKCW5	SOCKCB5	X	X	X	X	X	SOCKRAL5	368 x 84 x 12

MOTIVITY WALL detector			
MOTGW	MOTGB	X	90 x 90 x 8

MOTCW	MOTCB	X	X	X	X	X	MOTCRAL	84 x 84 x 6
-------	-------	---	---	---	---	---	---------	-------------

\*Until absolute.

KNX KNX\_CODE  
 12-24V DC NOC\_CODE  
 100-240V AC RET\_CODE  
 DEMO DEM\_CODE  
 FRONT FRD\_CODE

STONE BELGIAN BLUE	STONE FRENCH WHITE	STONE CARRARA BIANCO MARBLE	STONE CEPPPO DI GRES LIMESTONE	STONE CALACATTA MARBLE	STONE EMPERADOR GREY MARBLE	STONE EMPERADOR MARRON MARBLE	STONE OAK WHITE MARBLE	DIMENSIONS (mm)
--------------------	--------------------	-----------------------------	--------------------------------	------------------------	-----------------------------	-------------------------------	------------------------	-----------------

WOOD AFRRORMOSIA	WOOD ASH	WOOD OAK COTTON WHITE	WOOD OAK DARK	WOOD OAK PURA NATURA	WOOD PADOUK	WOOD WALNUT	WOOD WENGE	DIMENSIONS (mm)
------------------	----------	-----------------------	---------------	----------------------	-------------	-------------	------------	-----------------

INTENSITY switch											
	1F	X	X	X	X	X	X	X	X	X	X
	2F	X	X	X	X	X	X	X	X	X	X
	4F	INTSBB4	INTSFW4	INTSCBM4	INTSCDGL4	INTSCM4	INTSEGM4	INTSEMM4	INTSOWM4	90 x 90 x 8	
	8F	On request	On request	On request	on request	On request	On request	On request	On request	X	
	1F	X	X	X	X	X	X	X	X	X	
	2F	X	X	X	X	X	X	X	X	X	
	4F	X	X	X	X	X	X	X	X	X	

X	X	X	X	X	X	X	X	X	X
X	X	X	X	X	X	X	X	X	X
INTWAF4	INTWAS4	INTWOCW4	INTWOD4	INTWOPN4	INTWPA4	INTWWA4	INTWWE4	90 x 90 x 8	
On request	On request	On request	on request	On request	On request	On request	On request	X	
X	X	X	X	X	X	X	X	X	
X	X	X	X	X	X	X	X	X	
X	X	X	X	X	X	X	X	X	

INFINITY room controller (KNX only)											
	OLED 4F	On request	On request	On request	On request	On request	On request	On request	On request	On request	X
	OLED 8F	X	X	X	X	X	X	X	X	X	X

On request	On request	On request	On request	On request	On request	On request	On request	On request	X
On request	On request	On request	On request	On request	On request	On request	On request	X	

SOCKET frame 12mm 55 x 55 mm									...	
	1F	SOCKSBB1	SOCKSFW1	SOCKSCBM1	SOCKSCDGL1	SOCKSCM1	SOCKSEGM1	SOCKSEMM1	SOCKSOWM1	90 x 90 x 10,5
	2F	SOCKSBB2	SOCKSFW2	SOCKSCBM2	SOCKSCDGL2	SOCKSCM2	SOCKSEGM2	SOCKSEMM2	SOCKSOWM2	161 x 90 x 10,5
	3F	SOCKSBB3	SOCKSFW3	SOCKSCBM3	SOCKSCDGL3	SOCKSCM3	SOCKSEGM3	SOCKSEMM3	SOCKSOWM3	232 x 90 x 10,5
	4F	On request	On request	On request	On request	On request	On request	On request	On request	X
	5F	X	X	X	X	X	X	X	X	X

SOCKWAF1	SOCKWAS1	SOCKWOCW1	SOCKWOD1	SOCKWOPN1	SOCKWPA1	SOCKWWA1	SOCKWWE1	90 x 90 x 10,5
SOCKWAF2	SOCKWAS2	SOCKWOCW2	SOCKWOD2	SOCKWOPN2	SOCKWPA2	SOCKWWA2	SOCKWWE2	161 x 90 x 10,5
SOCKWAF3	SOCKWAS3	SOCKWOCW3	SOCKWOD3	SOCKWOPN3	SOCKWPA3	SOCKWWA3	SOCKWWE3	232 x 90 x 10,5
On request	On request	On request	On request	On request	On request	On request	On request	X
On request	On request	On request	On request	On request	On request	On request	On request	X

MOTIVITY WALL detector	MOTSBB	MOTSFW	MOTSCBM	MOTSCDGL	MOTSCM	MOTSEGM	MOTSEMM	MOTSOWM	90 x 90 x 8
------------------------	--------	--------	---------	----------	--------	---------	---------	---------	-------------

MOTWAF	MOTWAS	MOTWOCW	MOTWOD	MOTWOPN	MOTWPA	MOTWWA	MOTWWE	90 x 90 x 8
--------	--------	---------	--------	---------	--------	--------	--------	-------------

KNX: KNX\_CODE  
12-24V DC NOC\_CODE  
100-240V AC RET\_CODE  
DEMO DEM\_CODE  
FRONT: FRO\_CODE

INVISIBLE switch		INVISIBLE	DIMENSIONS (MM)	TRIMLESS BOX FOR METAL/CORIAN/WOOD/INVISIBLE BRICK AND CONCRETE WALL	TRIMLESS BOX FOR METAL/CORIAN/WOOD/INVISIBLE PLASTERBOARD WALL	DIMENSIONS (MM)	COATING SPRAY FOR COMPOSITE ITEMS
X	1F	X	X	X	X	X	X
X	2F	X	X	X	X	X	X
	4F	INTINV4*	79 x 79 x 6	TRIM_SWITCHMCMWINV124_BC	TRIM_SWITCHMCMWINV124_P	178 x 200 x 63	COAT_SPRAY_COMP
X	8F	X	X	X	X	X	X

\* Matching Trimless box to be ordered separately.

SOCKET invisible		TRIMLESS BOX WITH INVISIBLE SOCKET BRICK AND CONCRETE WALL	TRIMLESS BOX WITH INVISIBLE SOCKET PLASTERBOARD WALL	DIMENSIONS (MM)
	1F	TRIM_SOCKINV1_BC	TRIM_SOCKINV1_P	165 x 165 x 12,8 (+ depth wall box)
	2F	TRIM_SOCKINV2_BC	TRIM_SOCKINV2_P	165 x 240 x 12,8 (+ depth wall box)
X	3F	X	X	X
X	4F	X	X	X
X	5F	X	X	X

KNX: KNX\_CODE  
12-24V DC NOC\_CODE  
DEMO DEM\_CODE

INTENSITY switch		PAINTABLE	WALLPAPER	DIMENSIONS (MM)	TRIMLESS BOX FOR METAL/CORIAN/WOOD/INVISIBLE BRICK AND CONCRETE WALL	TRIMLESS BOX FOR METAL/CORIAN/WOOD/INVISIBLE PLASTERBOARD WALL	DIMENSIONS (MM)	COATING SPRAY FOR COMPOSITE ITEMS
X	1F	X	X	X	X	X	X	X
X	2F	X	X	X	X	X	X	X
	4F	INTP4*	INTWP4*	84 x 84 x 6	TRIM_SWITCHMCMWINV124_BC	TRIM_SWITCHMCMWINV124_P	190 x 415 x 15,5 (+ depth wall box)	COAT_SPRAY_COMP
X	8F	X	X	X	X	X	X	X

SOCKET frame 6MM round 45 x 45 mm		schuko be/fr 1x rj45 usb a/c coax 2x rj45 ur			TRIMLESS BOX FOR METAL/CORIAN/WOOD/INVISIBLE BRICK AND CONCRETE WALL	TRIMLESS BOX FOR METAL/CORIAN/WOOD/INVISIBLE PLASTERBOARD WALL	DIMENSIONS (MM)	COATING SPRAY FOR COMPOSITE ITEMS
	1F	SOCK6MMRP1*	X	84 x 84 x 6	TRIM_SOCK6MMMCW1_BC	TRIM_SOCK6MMMCW1_P	200 x 200 x 15,5 (+ depth wall box)	COAT_SPRAY_COMP
	2F	SOCK6MMRP2*	X	155 x 84 x 6	TRIM_SOCK6MMMCW2_BC	TRIM_SOCK6MMMCW2_P	200 x 320 x 15,5 (+ depth wall box)	COAT_SPRAY_COMP
	3F	SOCK6MMRP3*	X	226 x 84 x 6	TRIM_SOCK6MMMCW3_BC	TRIM_SOCK6MMMCW3_P	190 x 415 x 15,5 (+ depth wall box)	COAT_SPRAY_COMP
	4F	X	X	X	X	X	X	X
	5F	X	X	X	X	X	X	X

SOCKET frame 6MM square 45 x 45 mm		schuko be/fr 1x rj45 usb a/c coax 2x rj45 ur			TRIMLESS BOX FOR METAL/CORIAN/WOOD/INVISIBLE BRICK AND CONCRETE WALL	TRIMLESS BOX FOR METAL/CORIAN/WOOD/INVISIBLE PLASTERBOARD WALL	DIMENSIONS (MM)	COATING SPRAY FOR COMPOSITE ITEMS
	1F	SOCK6MMSP1*	X	84 x 84 x 6	TRIM_SOCK6MMMCW1_BC	TRIM_SOCK6MMMCW1_P	200 x 200 x 15,5 (+ depth wall box)	COAT_SPRAY_COMP
	2F	SOCK6MMSP2*	X	155 x 84 x 6	TRIM_SOCK6MMMCW2_BC	TRIM_SOCK6MMMCW2_P	200 x 320 x 15,5 (+ depth wall box)	COAT_SPRAY_COMP
	3F	SOCK6MMSP3*	X	226 x 84 x 6	TRIM_SOCK6MMMCW3_BC	TRIM_SOCK6MMMCW3_P	190 x 415 x 15,5 (+ depth wall box)	COAT_SPRAY_COMP
	4F	X	X	X	X	X	X	X
	5F	X	X	X	X	X	X	X

\* Matching Trimless box to be ordered separately, in case of 100% recessed, is required.

KNX: KNX\_CODE  
 12-24V DC: NOC\_CODE  
 100-240V AC: RET\_CODE  
 DEMO: DEM\_CODE  
 FRONT: FRO\_CODE

ELECTRONICS INTEGRATED	WALLBOX INTEGRATED WITH GAP	DIMENSIONS (MM)
------------------------	-----------------------------	-----------------

INTENSITY integrated switch with gap				
	1F	INTINT1	TRIM_INTINT124_WG	125 x 125 x 14 (+ depth wall box + finish)
	2F	INTINT2	TRIM_INTINT124_WG	125 x 125 x 14 (+ depth wall box + finish)
	4F	INTINT4	TRIM_INTINT124_WG	125 x 125 x 14 (+ depth wall box + finish)
	4F	INTINVINT4	TRIM_INTINVINT4_WG	125 x 125 x 11 (+ depth wall box + finish)

SOCKET integrated with gap 45 x 45 mm									
		schuko	be/fr	1x rj45	usb a/c	coax	2x rj45	uk	...
	1F	X							
	2F	X							
	Shaver Socket*	X							
	RJ45 Socket*	X							

\* Insert included

KNX: KNX\_CODE  
 12-24V DC: NOC\_CODE  
 DEMO: DEM\_CODE

ELECTRONICS INTEGRATED	WALLBOX INTEGRATED NO GAP	DIMENSIONS (MM)
------------------------	---------------------------	-----------------

INTENSITY integrated switch no gap*				
	1F Intensity	INTINT1	TRIM_INTINT124_NG	125 x 125 x 22,9 (+ depth wall box + finish)
	2F Intensity	INTINT2	TRIM_INTINT124_NG	125 x 125 x 22,9 (+ depth wall box + finish)
	4F Intensity	INTINT4	TRIM_INTINT124_NG	125 x 125 x 22,9 (+ depth wall box + finish)

\* Only to be installed when accessible from the backside

SOCKET integrated no gap 45 x 45 mm									
		schuko	be/fr	1x rj45	usb a/c	coax	2x rj45	uk	...
	1F Socket	X							
	2F Socket	X							
	Shaver socket	X			X				X
	RJ45 Socket	X			X				X

MISCELLANEOUS

Glue Kit electronics*	INTINT_GLUKIT
Glueing Pistol**	INTINT_GLUPISTOL

MISCELLANEOUS

Coating spray for stone items	COAT_SPRAY_STONE
Glueing Pistol**	INTINT_GLUPISTOL

\* Electronics can only be glued to stone/ceramics using this glue. Wood/MDF can be glued to the electronics by using the special double-sided label which is included.  
 The wallbox can be glued by using this glue on any other suitable glue.  
 \*\* Can be reused many times.

KNX: KNX\_CODE  
 12-24V DC: NOC\_CODE  
 DEMO: DEM\_CODE  
 FRONT: FRO\_CODE

BLACK	WHITE	DIMENSIONS (MM)
-------	-------	-----------------

TRIMLESS BOX FOR BRICK & CONCRETE WALL/CEILING	TRIMLESS BOX FOR PLASTERBOARD WALL/CEILING	DIMENSIONS (MM)
--	--	-----------------

MOTIVITY detector

CEILING	PIR	MOTIB	MOTIW	ø 17,5 x 89
LINE	PIR	MOTLIB	MOTLIW	32 x 12 x 89
PLUS*	PIR	MOTPLUS_B	MOTPLUS_W	ø 73 x 30
ANGLE	BRACKET	MOTPLUS_ANGLE_B	MOTPLUS_ANGLE_W	ø 73 x 62,3
SAPP	PIR + BRACKET	MOTSIB	MOTSIW	19 x 44 x 41,5
PLASTERBOARD	PIR + BRACKET	MOTPBIB	MOTPBIW	18 x 18 x 54,6

X	X	X
X	X	X
TRIM_MOTPLUS_BC	TRIM_MOTPLUS_P	200 x 200 x 36
X	X	X
X	X	X
X	X	X

\* Matching Trimless box to be ordered separately in case 100% recessed is requested.

DEMO DEM\_CODE

	ALU, ALU BLACK, ALU WHITE, BRONZE	CHROME, FORGED ALU, STAINLESS STEEL, FORGED STAINLESS STEEL	FORGED ALU DARK GREY, FORGED ALU BLACK, LANDSCAPE ALU DARK GREY	DIMENSIONS (mm)	BRONZE LIGHT, FORGED BRONZE LIGHT, FORGED BRONZE FORGED STEEL BRUSHED COPPER ROSE, FORGED COPPER ROSE, BRUSHED GOLD, FORGED GOLD	DIMENSIONS (mm)
DEMONSTRATION TOOLS	INTMIX4_C	INTMIX4_D	INTMIX4_E	84 x 84 x 6	INTMIX8_H	165 x 84 x 6

CODE	DIMENSIONS (MM)
------	-----------------

ELECTRICAL BOX SWITCH & SOCKET COMBO	BCU_EBSS02	158 x 73 x 45,5
ELECTRICAL BOX SWITCH & MOTIVITY COMBO	BCU_EBSM02	158 x 73 x 45,5
ELECTRICAL BOX SWITCH & 2F SOCKET COMBO	BCU_EBSS03	158 x 73 x 45,5

TRIMLESS BOX FOR METAL/CORIAN/WOOD/INVISIBLE BRICK AND CONCRETE WALL	TRIMLESS BOX FOR METAL/CORIAN/WOOD/INVISIBLE PLASTERBOARD WALL	TRIMLESS BOX FOR GLASS/STONE BRICK AND CONCRETE WALL	TRIMLESS BOX FOR GLASS/STONE PLASTERBOARD WALL	DIMENSIONS (mm)
--	--	--	--	-----------------

INTENSITY - SERENITY - VELOCITY switch									
	1F	TRIM_SWITCHMCWINV124_BC	TRIM_SWITCHMCWINV124_P	TRIM_SWITCHGS124_BC	TRIM_SWITCHGS124_P	178 x 200 x 63			
	2F	TRIM_SWITCHMCWINV124_BC	TRIM_SWITCHMCWINV124_P	TRIM_SWITCHGS124_BC	TRIM_SWITCHGS124_P	178 x 200 x 63			
	4F	TRIM_SWITCHMCWINV124_BC	TRIM_SWITCHMCWINV124_P	TRIM_SWITCHGS124_BC	TRIM_SWITCHGS124_P	178 x 200 x 63			
	8F	TRIM_SWITCHMCW8_BC	TRIM_SWITCHMCW8_P	TRIM_SWITCHGS8_BC	TRIM_SWITCHGS8_P	178 x 320 x 63			
	1F	TRIM_SWITCHMCWINV124_BC	TRIM_SWITCHMCWINV124_P	TRIM_SWITCHGS124_BC	TRIM_SWITCHGS124_P	178 x 200 x 63			
	2F	TRIM_SWITCHMCWINV124_BC	TRIM_SWITCHMCWINV124_P	TRIM_SWITCHGS124_BC	TRIM_SWITCHGS124_P	178 x 200 x 63			
	4F	TRIM_SWITCHMCW8_BC	TRIM_SWITCHMCW8_P	TRIM_SWITCHGS8_BC	TRIM_SWITCHGS8_P	178 x 320 x 63			
INFINITY room controller (KNX only)									
	OLED	TRIM_SWITCHMCWINV124_BC	TRIM_SWITCHMCWINV124_P	TRIM_SWITCHGS124_BC	TRIM_SWITCHGS124_P	178 x 200 x 63			
	OLED	TRIM_SWITCHMCW8_BC	TRIM_SWITCHMCW8_P	TRIM_SWITCHGS8_BC	TRIM_SWITCHGS8_P	178 x 320 x 63			
SOCKET frame 12mm									
									...
	1F	TRIM_SOCKMCW1_BC	TRIM_SOCKMCW1_P	TRIM_SOCKGS1_BC	TRIM_SOCKGS1_P	200 x 200 x 20 (+ depth wall box)			
	2F	TRIM_SOCKMCW2_BC	TRIM_SOCKMCW2_P	TRIM_SOCKGS2_BC	TRIM_SOCKGS2_P	200 x 320 x 20 (+ depth wall box)			
	3F	TRIM_SOCKMCW3_BC	TRIM_SOCKMCW3_P	TRIM_SOCKGS3_BC	TRIM_SOCKGS3_P	190 x 415 x 20 (+ depth wall box)			
	4F	X	X	X	X	X			
	5F	X	X	X	X	X			
SOCKET frame 6mm round									
									...
	1F	TRIM_SOCK6MMMCW1_BC	TRIM_SOCK6MMMCW1_P	X	X	200 x 200 x 15,5 (+ depth wall box)			
	2F	TRIM_SOCK6MMMCW2_BC	TRIM_SOCK6MMMCW2_P	X	X	200 x 320 x 15,5 (+ depth wall box)			
	3F	TRIM_SOCK6MMMCW3_BC	TRIM_SOCK6MMMCW3_P	X	X	190 x 415 x 15,5 (+ depth wall box)			
	4F	X	X	X	X	X			
	5F	X	X	X	X	X			
SOCKET frame 6mm square									
									...
	1F	TRIM_SOCK6MMMCW1_BC	TRIM_SOCK6MMMCW1_P	X	X	200 x 200 x 15,5 (+ depth wall box)			
	2F	TRIM_SOCK6MMMCW2_BC	TRIM_SOCK6MMMCW2_P	X	X	200 x 320 x 15,5 (+ depth wall box)			
	3F	TRIM_SOCK6MMMCW3_BC	TRIM_SOCK6MMMCW3_P	X	X	190 x 415 x 15,5 (+ depth wall box)			
	4F	X	X	X	X	X			
	5F	X	X	X	X	X			
MOTIVITY WALL detector		TRIM_SWITCHMCWINV124_BC	TRIM_SWITCHMCWINV124_P	TRIM_SWITCHGS124_BC	TRIM_SWITCHGS124_P	187,5 x 221 x 50,5			
MOTIVITY PLUS detector		TRIM_MOTPLUS_BC	TRIM_MOTPLUS_P	X	X	200 x 200 x 36			

